

GLEN BURNIE MD 21061
BLVD - FERNDALE
25 BALTIMORE - ANNAPOLIS
RICHARD B FONES JR
RST-2071 R 40 1274

April, 1974 □ 75 cents

Electronic Servicing

A HOWARD W. SAMS PUBLICATION

Installing Antenna Towers

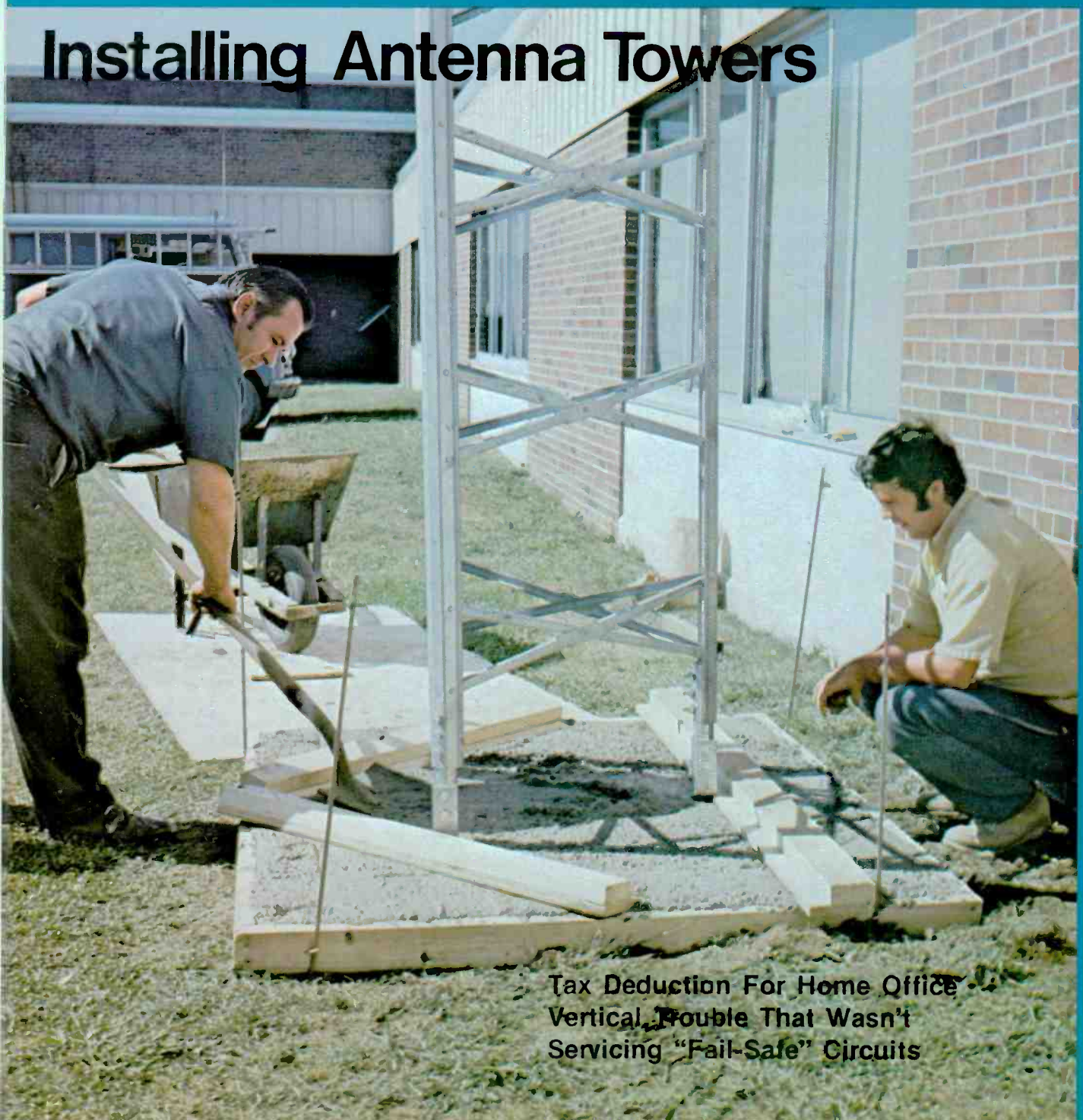

Tax Deduction For Home Office
Vertical Trouble That Wasn't
Servicing "Fail-Safe" Circuits

HOME OFFICE—INDIANA:
5233 S. HWY. 37
BLOOMINGTON, INDIANA 47401
TEL. 812, 824-9331

CALIFORNIA—NORTH:
PTS ELECTRONICS, INC.
4611 AUBURN BLVD.
SACRAMENTO, CALIF. 95841
TEL. 916, 482-6220

CALIFORNIA—SOUTH:
PTS ELECTRONICS, INC.
5111 UNIVERSITY AVE
SAN DIEGO, CALIF. 92105
TEL. 714, 280-7070

COLORADO:
PTS ELECTRONICS, INC.
4958 ALLISON ST.
ARVADA, COLO. 80001
TEL. 303, 423-7080

FLORIDA:
PTS ELECTRONICS, INC.
1918 BLANDING BLVD
JACKSONVILLE, FLA. 32210
TEL. 904, 389-9952

INDIANA:
PTS ELECTRONICS, INC.
5233 S. HWY 37
BLOOMINGTON, IND. 47401
TEL. 812, 824-9331

KANSAS:
PTS ELECTRONICS, INC.
3116 MERRIAM LANE
KANSAS CITY, KANSAS 66100
TEL. 913, 831-1222

LOUISIANA:
PTS ELECTRONICS, INC.
2914 WYCHWOOD DRIVE
METAIRIE, LOUISIANA 70033
TEL. 504, 885-2349

MARYLAND:
PTS ELECTRONICS, INC.
1105 SPRING ST
SILVER SPRING, MD. 20910
TEL. 301, 565-0025

MASSACHUSETTS:
PTS ELECTRONICS, INC.
191 CHESTNUT ST
SPRINGFIELD, MASS. 01103
TEL. 413, 734-2737

MINNESOTA:
PTS ELECTRONICS, INC.
815 W. LAKE ST
MINNEAPOLIS, MINN. 55408
TEL. 612, 824-2333

NEW YORK:
PTS ELECTRONICS, INC.
993 SYCAMORE ST
BUFFALO, N.Y. 14212
TEL. 716, 891-4935

NEW YORK CITY—NEW JERSEY:
PTS ELECTRONICS, INC.
158 MARKET ST
E. PATERSON, N.J. 07407
TEL. 201, 791-6380

NORTH CAROLINA:
PTS ELECTRONICS, INC.
724 SIEGLE AVE
CHARLOTTE, N. C. 28205
TEL. 704, 332-8007

OHIO:
PTS ELECTRONICS, INC.
5682 STATE RD
CLEVELAND, OHIO 44134
TEL. 216, 845-4480

OKLAHOMA:
PTS ELECTRONICS, INC.
3007 N. MAY
OKLAHOMA CITY, OKLA. 73106
TEL. 405, 947-2013

OREGON:
PTS ELECTRONICS, INC.
5220 N.E. SANDY BLVD
PORTLAND, OREGON 97213
TEL. 503, 282-9636

PENNSYLVANIA—EAST:
PTS ELECTRONICS, INC.
1921 S. 70TH ST
PHILADELPHIA, PA. 19142
TEL. 215, 724-0999

PENNSYLVANIA—WEST:
PTS ELECTRONICS, INC.
257 RIVERVIEW AVE W
PITTSBURGH, PA. 15202
TEL. 412, 761-7648

TEXAS—NORTH:
PTS ELECTRONICS, INC.
MOPAC LANE
LONGVIEW, TEX. 75601
TEL. 214, 753-4334

TEXAS—EAST:
PTS ELECTRONICS, INC.
4324-26 TELEPHONE RD
HOUSTON, TEX. 77032
TEL. 713, 644-6793

PTS ELECTRONICS

Precision Tuner Service

is proud to announce the
GRAND OPENING
of our new Service Center in

CHARLOTTE, N. CAROLINA

now you too get...

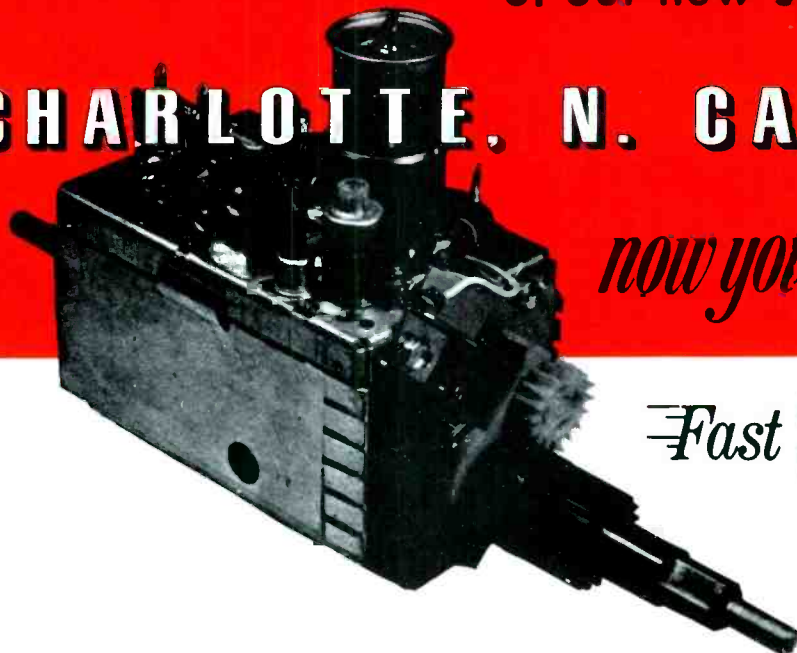

Fast **8** hr. Service!
\$9.95

1 YEAR GUARANTEE

FREE JOB CARDS . FREE SHIPPING LABELS

Come and see us. PTS Branches are all company owned—No Franchises—we care for our customers. For a TUNER PART or COMPLETE TUNER REBUILT, come to us, we will take care of your tuner problems like no one else can. WE'RE PROFESSIONALS—18 years experience made us what we are!

You owe it to yourself

to try P.T.S. We are the fastest growing, oldest and now the largest tuner service company in the world. Here is what you get:

1. **Fastest Service**—8 hour—in and out the same day. Overnight transit to one of our plants.
2. **Fine Quality!** Your customers are satisfied and you are not bothered with returning tuners for rework!
3. **Lower Cost!** Up to \$5.50 less than other tuner companies!
4. **Friendly, helpful service!** We help you do more business—that way we will do more, too. We want your business and we try to deserve it!

Color • Black & White • Transistor
• Tubes • Varactor • Detent UHF
All Makes

VHF or UHF..... **\$9.95**

UV-Comb..... **\$16.95**

Major parts and shipping
charged at cost.
(Dealer net!)

for finer, faster,

... **Precision**

Tuner Service

send faulty unit with tubes, shields and all broken parts to:

PTS ELECTRONICS, INC.
P. O. BOX 5512
724 SIEGLE AVENUE
CHARLOTTE, N. C. 28205
TEL. 704, 332-8007

or to any of our strategically located Service Centers

Take a leaf from the Mallory Money Tree and save on famous Mallobins.[®]

Our Mallobin benchtop organizers are worth many times their modest cost in keeping electronic components neatly sorted, labeled, protected and ready for use. Now, you can save on buying them, too. For

instance, this PTC semiconductor Mallobin organizer can be purchased at a special discount at your Mallory Distributor. Just present the Mallory Money Tree coupon below.



MALLORY DISTRIBUTOR PRODUCTS COMPANY
a division of P. R. MALLORY & CO. INC.
Box 1284, Indianapolis, Indiana 46206; Telephone: 317-636-5353

Batteries • Capacitors • Controls • Security Products • DURATAPE[®] • Recorders • Resistors • SEMICONDUCTORS • SONALERT[®] • Switches • Timers



DURATAPE[®] and SONALERT[®] are registered trademarks of P. R. Mallory & Co. Inc.

Money Tree Coupon

This coupon valid through Sept. 1, 1974. Only one coupon valid on each purchase. This coupon not valid where prohibited or taxed by law. Coupon does not apply to sales tax, if applicable.

TO MALLORY DISTRIBUTOR

This coupon redeemable for \$1.00 credit towards the purchase of any Mallory products or \$1.00 in cash provided it is tendered to Mallory Distributor Products Company, a division of P. R. Mallory & Company Inc., Indianapolis, Indiana prior to Oct. 1, 1974. Invoices showing purchase of Mallobin organizers sufficient to cover coupon must be shown on request.

Worth
\$100
OFF
on any purchase of any Mallory Mallobin organizer at a Mallory Distributor.

ES44

electronic scanner

news of the industry

Large amounts of power might be transmitted over long distances in the future using DC instead of the conventional AC power. Most long-distance energy transmission today is at 500,000-volts AC, but transmitting the same amount of energy by means of 800,000-volts DC lines would require much less copper wire, and thus considerably reduce transmission loss. Only two wires are required for DC, versus three or four for AC. In practice, AC is generated, converted to DC, transmitted to a substation near where the power is needed, and reconverted to AC. For example, a portion of the power for Los Angeles comes from the Pacific northwest by way of a line 846 miles long. At Sylmar Station near Los Angeles, 42 mercury-arc converters (filling a building as large as a football field) change the DC into AC. Today, systems are being constructed in a fraction of that space using silicon controlled rectifiers (SCR's). It seems likely that most—perhaps all—future installations and expansions will utilize DC transmission.

WTAF-TV, Channel 29 in Philadelphia, has just christened the most powerful TV system in the nation, according to TSA of Delaware Valley. The new 165-kW UHF transmitter coupled to a new pylon antenna produces five-million watts of effective radiated power. It is said the new system extends the prime coverage area to almost 10,000 square miles, an increase of about 70 per cent. Except for four klystron power-amplifier tubes, the transmitter is all-solid-state.

RCA has just opened in Franklin Township, New Jersey a new 60,000 square-foot facility to be used primarily for the engineering and manufacturing of liquid-crystal displays for electronic clocks and calculators, reports **Home Furnishings Daily**. About 100 persons are now employed, but more will be added as needed.

Shades of the Philco Predicta! This was your editor's reaction to the JVC Model 3100R "video capsule" b-w television receiver (see photo). Both a digital clock-timer and a TV receiver are built into a clamshell cabinet, which can be closed for operation as a clock, or opened for TV reception.

(Courtesy of JVC)



(Continued on page 6)



\$9.95

ALL PARTS INCLUDED
EXCEPT TUBES & TRANSISTORS

ONE YEAR GUARANTEE

TUNER SERVICE CORPORATION

PROVIDES YOU WITH A COMPLETE SERVICE FOR ALL YOUR TELEVISION TUNER REQUIREMENTS.

REPLACE

Universal Replacement Tuner **\$9.95** (In Canada \$14.95)

This price buys you a complete new tuner built specifically by **SARKES TARZIAN INC.** for this purpose.

All shafts have a maximum length of 10½" which can be cut to 1½".

Specify heater type parallel and series 450mA or 600mA.

REPAIR

VHF Or UHF Any Type **\$9.95.**
UHF/VHF Combo **\$15.00.**

In this price all parts are included, tubes, transistors, diodes, and nuvistors are charged extra. This price does not cover mutilated tuners.

Fast efficient service at our conveniently located service centers.

All tuners ultrasonically cleaned, repaired, realigned and air tested.

CUSTOMIZE

Customized tuners are available at a cost of only **\$15.95;** (with trade-in **\$13.95**) (In Canada \$17.95/\$15.95)

Send in your original tuner for comparison purposes.



HEADQUARTERS	BLOOMINGTON, INDIANA 47401	537 S. Walnut Street	Tel. 812-334-0411
ARIZONA	TUCSON, ARIZONA 85713	1528 So. 6th Street, P.O. Box 4534	Tel 602-791-9243
CALIFORNIA	NORTH HOLLYWOOD, CALIF. 91601	10654 Magnolia Boulevard	Tel. 213-769-2720
	BURLINGAME, CALIF. 94010	1324 Marsten Road	Tel. 415-347-5728
	MODESTO, CALIF. 95351	123 Phoenix Avenue	Tel. 209-521-8051
FLORIDA	TAMPA, FLORIDA 33606	1505 Cypress Street	Tel. 813-253-0324
GEORGIA	ATLANTA, GEORGIA 30310	938 Gordon Street S.W.	Tel. 404-758-2232
ILLINOIS	CHICAGO, ILLINOIS 60621	737 West 55th Street	Tel. 312-873-5556-7
	SKOKIE, ILLINOIS 60076	3110 West Brown Street	Tel. 312-675-0230
INDIANA	HAMMOND, INDIANA 46323	6833 Grand Avenue	Tel. 219-845-2676
	INDIANAPOLIS, INDIANA 46204	817 North Pennsylvania St.	Tel. 317-632-3493
KENTUCKY	LOUISVILLE, KENTUCKY 40208	2920 Taylor Boulevard	Tel. 502-634-3334
LOUISIANA	SHREVEPORT, LOUISIANA 71104	3025 Highland Ave	Tel. 318-861-7745
MARYLAND	BALTIMORE, MD 21215	5505 Reisterstown Rd., P.O. Box 2624	Tel. 301-358-1186
MISSOURI	ST. LOUIS, MISSOURI 63132	10530 Page Avenue	Tel. 314-429-0633
NEVADA	LAS VEGAS, NEVADA 89102	1412 Western Ave. No. 1	Tel. 702-384-4235
NEW JERSEY	JERSEY CITY, NEW JERSEY 07307	547-49 Tunnel Avenue HWY 1&9	Tel. 201-792-3730
	TRENTON, NEW JERSEY 08638	901 N. Olden Ave.	Tel. 609-393-0999
OHIO	CINCINNATI, OHIO 45216	7450 Vine Street	Tel. 513-821-5080
	CLEVELAND, OHIO 44109	4597 Pearl Road	Tel. 216-741-2314
	TOLEDO, OHIO 43624	119 North Erie Street	Tel. 419-243-6733
OREGON	PORTLAND, OREGON 97210	1732 N.W. 25th Avenue	Tel. 503-222-9059
TENNESSEE	GREENEVILLE, TENNESSEE 37743	1215 Snapps Ferry Road	Tel. 615-639-8451
	MEMPHIS, TENNESSEE 38111	3158 Barron Ave.	Tel. 901-458-2355
TEXAS	DALLAS, TEXAS 75218	11540 Garland Road	Tel. 214-327-8413
VIRGINIA	NORFOLK, VIRGINIA 23502	4538 East Princess Anne Rd.	Tel. 703-855-2518
CANADA	ST. LAURENT, MONTREAL, QUEBEC H4N-2L7	305 Decarie Blvd.	Tel. 514-748-8803

WATCH US GROW

FOR INFORMATION ON FRANCHISE, CONTACT HEADQUARTERS

Sony TV receivers using 25-inch Trinitron color picture tubes are planned for sale next fall in Japan. According to **Home Furnishings Daily**, the receivers are to sell for \$1,170. It is expected the sets will be introduced into the United States in 1975. In fact, the Sony plant in San Diego, California might build them.

Some fringe benefits given to employees can be tax deductible as business expenses of employers, the **Hoosier Test Probe** reports. For example, premiums for insurance, hospitalization, or medical care are deductible if the employer can show: that the premiums are part of the compensation paid at present; that the total of salary and premiums represents reasonable compensation; and that the employee, not the employer, benefits from the policy. Check with your IRS office, if you have questions.

Panasonic has introduced a new Quintrix color picture tube for use in the Quatrecolor television line. An additional focusing lens is included in each electron gun. This is said to produce a smaller beam spot at the screen phosphors, resulting in sharp focus even at high brightness. The Quintrix tube is of the black matrix type for improved contrast, and the color dots are affixed to the screen by the direct exposure method, said to produce better purity. Quintrix picture tubes first will be used in 19-inch receivers.

An extremely-thin, rectangular-shaped 6-volt battery has been developed by the Mallory Battery Company. The FLAT-PAK energy package is less than one-third-inch thick, one and seven-eighths inches long, and one and three-eighths inches wide. It contains four alkaline cells in series, and has terminals of unique shapes that make sure the battery can only be inserted with the correct polarity. First application is to power integrated-circuit calculators which are small enough to fit in a shirt pocket.

The General Electric Tube Products Department is stressing realism in the pictures used in its 1974 advertising. Instead of photographing in a studio and using professional models, the cameraman set up lights and equipment at the counter of Hutch & Son, local GE distributor in Louisville, Kentucky. Appearing in each picture were J. W. (Willie) Taylor, counterman, and Donald E. Brock, technician for Kirby's, a major appliance and television dealer. Advertisements containing these pictures are appearing in *Electronic Servicing*. □

the only prime time test pattern.

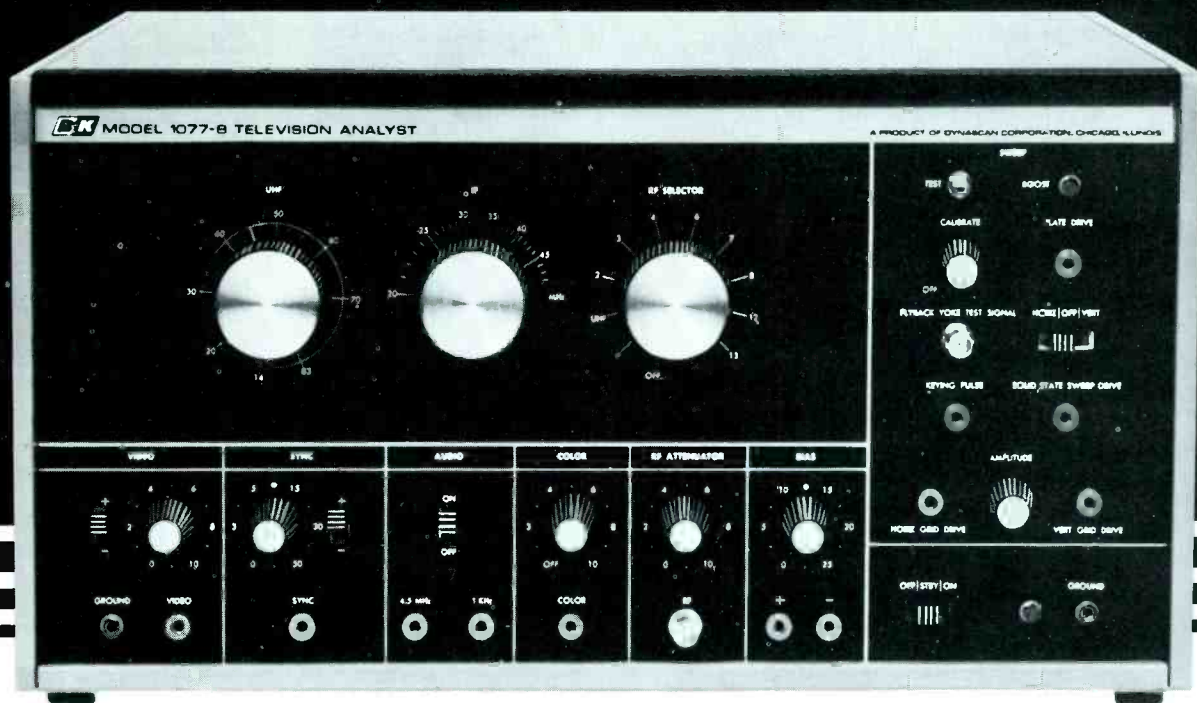

Model 1077B
\$425

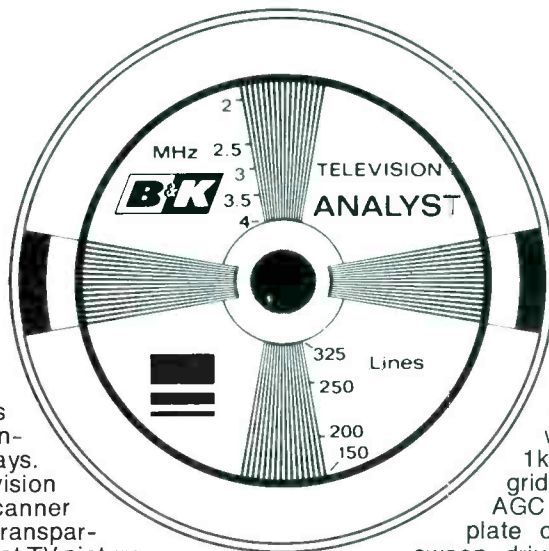

Remember the test pattern? Here's how to use that old standby to cut your troubleshooting time in half.

Broadcast test patterns are available only at very inconvenient times these days. So our Model 1077B Television Analyst has a flying-spot scanner that transforms any 3" x 4" transparency into a broadcast-format TV picture. We even supply you with a test pattern slide.

A test pattern provides valuable information about picture size, linearity, focus, resolution, ringing (overshoot), low-frequency phase shift (smear) and frequency response. Unless the TV receiver isn't working, of course.

That's why the 1077B provides signal-substitution outputs to let you inject the test pattern anywhere in the chain from the flyback all the way back to the antenna terminals. You can pinpoint the problem in minutes instead of hours, check-

ing the quality of each stage as you go.

Outputs include: IF, 8 VHF channels, all UHF channels, video, sync, 4.5MHz sound subcarrier with 1kHz FM modulation, 1kHz audio, chroma, vertical grid drive, horizontal grid drive, AGC keying pulse, horizontal plate drive, horizontal solid-state sweep drive, vertical plate drive and vertical solid state sweep drive.

There's also a built-in dot/bar/crosshatch generator for color TV chroma and convergence adjustments. Plus positive or negative bias supply and B+ boost indication. All level controls are conveniently located on the front panel.

There's nothing else like it.

Ask your distributor for Model 1077B, the latest in over 20 years of television analysts—in stock now or write Dynascan.



1801 W. Belle Plaine Ave. • Chicago, IL 60613 • Phone (312) 327-7270

Complete Line of Analog and Digital Multimeters, Oscilloscopes, Signal Generators, Semiconductor Testers, Power Supplies, Probes, Tube Testers and Substitution Boxes.

For More Details Circle (6) on Reply Card

**Chassis—Admiral K10
PHOTOFACT—1125-1**

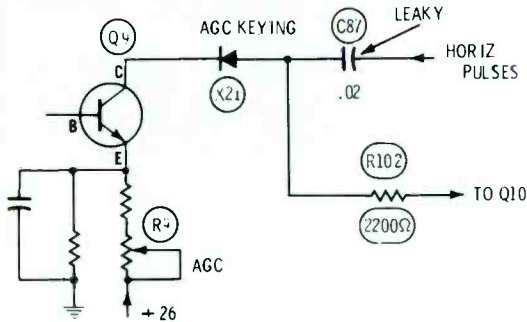

Symptom—Raster, but no picture; might be intermittent
Cure—Check C87, and replace if it is leaky

**Chassis—Admiral H10
PHOTOFACT—920-1**

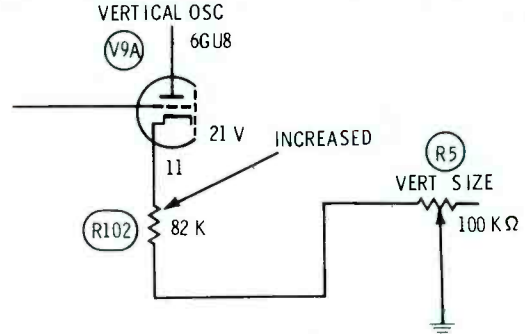

Symptom—Vertical hold control at one end
Cure—Check R102, and replace if it has increased in value

**Chassis—General Electric KC
PHOTOFACT—903-1**

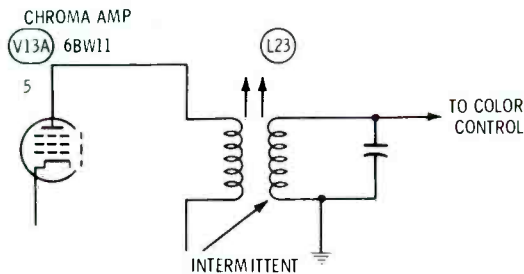

Symptom—No color, or intermittent color
Cure—Rotate L23 to check for loss of color; resolder pins if coil is intermittent

**Chassis—Magnavox T920
PHOTOFACT—887-2**

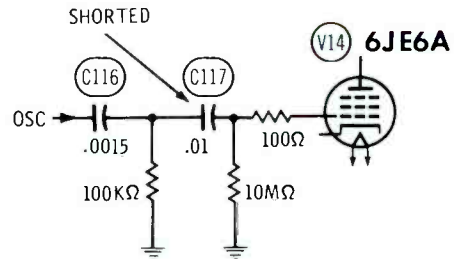

Symptom—No high voltage; output plate red
Cure—Check C117, and replace if it is leaky or shorted

**Chassis—Philco-Ford 18QT85
PHOTOFACT—954-2**

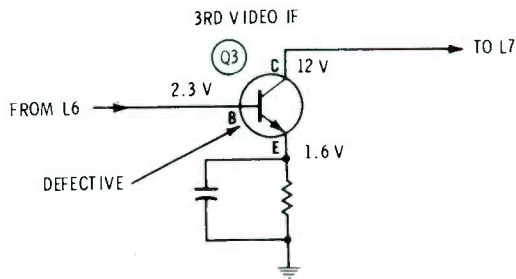

Symptom—Raster, but no picture
Cure—Check 3rd video IF, Q3, and replace if defective

**Chassis—Zenith 23XC36
PHOTOFACT—863-3**

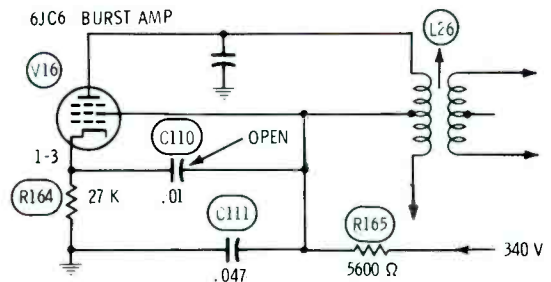

Symptom—Poor color locking
Cure—Check C110, and replace if it is open

troubleshootingtips

Send in your helpful tips—we pay!

Low sensitivity

Sylvania D16 color chassis
(Photofact 1178-3)

Contrast was low, there was not much snow off channel, and the AGC control would not blank out the picture. All symptoms pointed to low picture-IF gain.

After trying new IF transistors, measuring voltages, and checking waveforms, I was sure the problem was in the first IF stage. By paralleling the capacitors with good ones, I discovered that C208 was

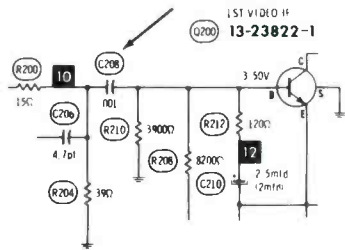

open, and a new one brought back the original performance. Evidently the stray capacity was feeding a small amount of signal through the open component.

Serge Thibodeau
Quebec, Canada

No high voltage, then poor linearity

Teledyne Packard Bell 98C9 color chassis
(Photofact 854-3)

There was no high voltage and the drive at the grid of the horizontal output tube was slightly low. The 6JE6 output tube had a small crack in the glass and replacing the tube brought back the high voltage and raster.

However, the picture was narrow on the right and expanded on the left edge. Sometimes a weak damper tube will cause these symptoms, but the 6DW4 checked fine in my lab-grade tube tester.

After vainly checking other possibilities (such as a leaky coupling capacitor between oscillator and output), I replaced the damper tube. You guessed it! That cured the poor width and linearity.

Joseph Rotello, Jr.
Tucson, Arizona

... capacitor shortages causing replacement problems and servicing delays?

Maybe that old capacitor is still good ...

check it out with the

SPRAGUE

MODEL **TEL-OHMIKE®**
TO-6A

CAPACITOR ANALYZER

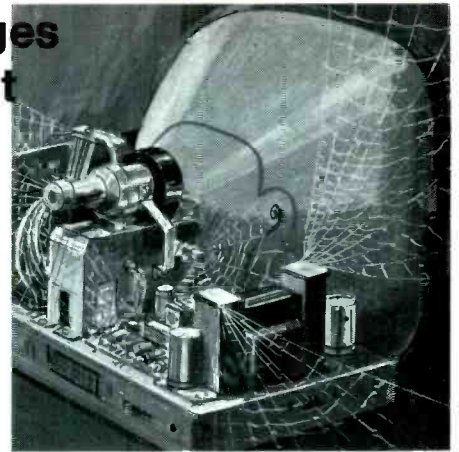

Laboratory quality and accuracy, yet priced so you can afford it ... \$158²⁵ NET!

Measures Capacitance. Up to 2000 μ F in 5 overlapping ranges, including an exclusive 1 to 100 pF range.

Measures Power Factor. Utilizes the highly accurate Wien Bridge method. Reads up to 50% in 3 ranges.

Measures Leakage Current of aluminum electrolytics. Easy-to-read meter, with exact rated voltage (up to 600 V) applied from adjustable power supply.

Measures Insulation Resistance. For paper, film, ceramic, mica capacitors. Dual range—to 100KM Ω at 25V, to 50 KM Ω at 150V.

Get a demonstration from your Sprague Distributor today ... or, order directly from Sprague Products Company, 105 Marshall Street, North Adams, Mass. 01247.

(Prices subject to change without notice)

65-4104

SPRAGUE®

THE MARK OF RELIABILITY

THE BROAD-LINE PRODUCER OF ELECTRONIC PARTS

For More Details Circle (7) on Reply Card

troubleshootingtips

(Continued from previous page)

No raster, open contrast control

RCA CTC31 color chassis (Photofact 928-3)

In the CTC31, one of the common causes of no raster (when the high voltage is normal) is an open

contrast control. This biases both the video output tube and the picture tube to cutoff. A shorted 12HG7 video tube might burn open the element, or the control might go bad of itself.

However, I have found several cases where internal arcing or leakage between the degenerative capacitor (C1D) and other capacitors in the same can had overloaded the control, causing failure.

To be absolutely certain, replace the tube and the multi-section capacitor when you install a new contrast control.

Thomas A. Singletary
Statesboro, Georgia

No sound, no raster Zenith 25DC56 color chassis (Photofact 1312-3)

The symptoms indicated a loss of power; only the dial lamp was lit.

The fuses checked all right, then voltage measurements proved a loss of the 125-volt supply. I traced the 125-volt supply into and out of several modules until I found a loose plug on the chroma module that had opened the circuit.

The receiver was 13 months old and had not given any trouble previously, although the interlock connections had been arcing and overheating all that time. In fact, the contacts were burned so badly that the module had to be replaced. Moral: make sure all the modules are firmly seated and making good contact.

Ken Barton, CET
Columbus, Ohio

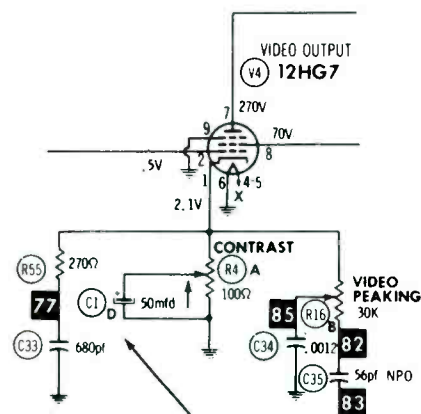

Poor or intermittent focus Color sets with HV focus

If you have a complaint of varying focus, but nothing checks defective, and the performance is normal when the chassis is operated on your test jig, suspect the picture tube.

But don't be too quick to replace it. Some tubes can be repaired easily.

Have the entire set in operation, then remove the base socket from the neck of the picture tube. Measure with a HV probe from the focus pin of the picture tube to ground; there should be zero volts.

In many cases, from 3kV to 7kV can be measured. If so, just use a jumper wire to ground the focus pin. You'll hear a snap from inside the picture tube, and a second voltage check shows no voltage.

Evidently internal leakage bleeds some of the high voltage over to the focus electrode, and the short circuit burns it out.

Parkhurst TV Shop
Gloucester, Mass.

Editors note: I agree with the diagnosis and the method of curing the problem. Not one of the several tubes I have repaired that way was damaged or had a recurrence of the trouble.

Dark picture General Electric HC color chassis (Photofact 883-3)

After turning on the receiver, I saw no problems for about ten minutes. Then the picture dimmed, lost horizontal locking, and the picture seemed to have only red and purple hues. The symptoms lasted only about thirty seconds before returning to normal, but the trouble recurred about three or four times within a half hour.

First, I tested the 11BT11 (video amplifier, AGC keyer, and sync tube), but it was okay.

Next, I started checking resistances in the AGC section, and found R48 to measure 85K instead of 100K ohms. Replacing this part did not solve the intermittent.

After further searching, I found

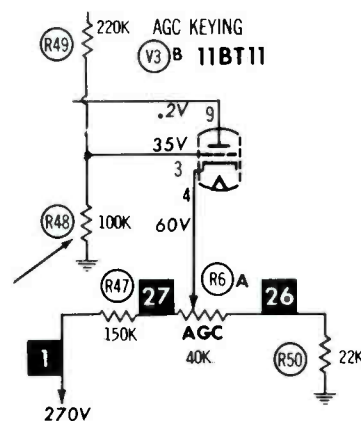

C106 and C107 burned so badly they crumbled at a touch. Replacement of both capacitors solved the problem.

Paul Specht
Jensen Beach, Florida

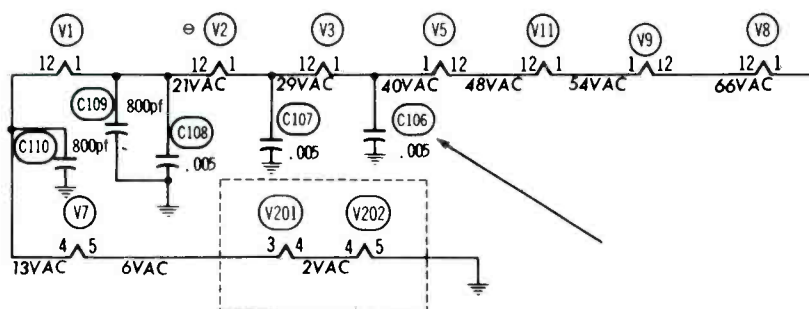

How to sell a TV antenna to a cable TV subscriber.

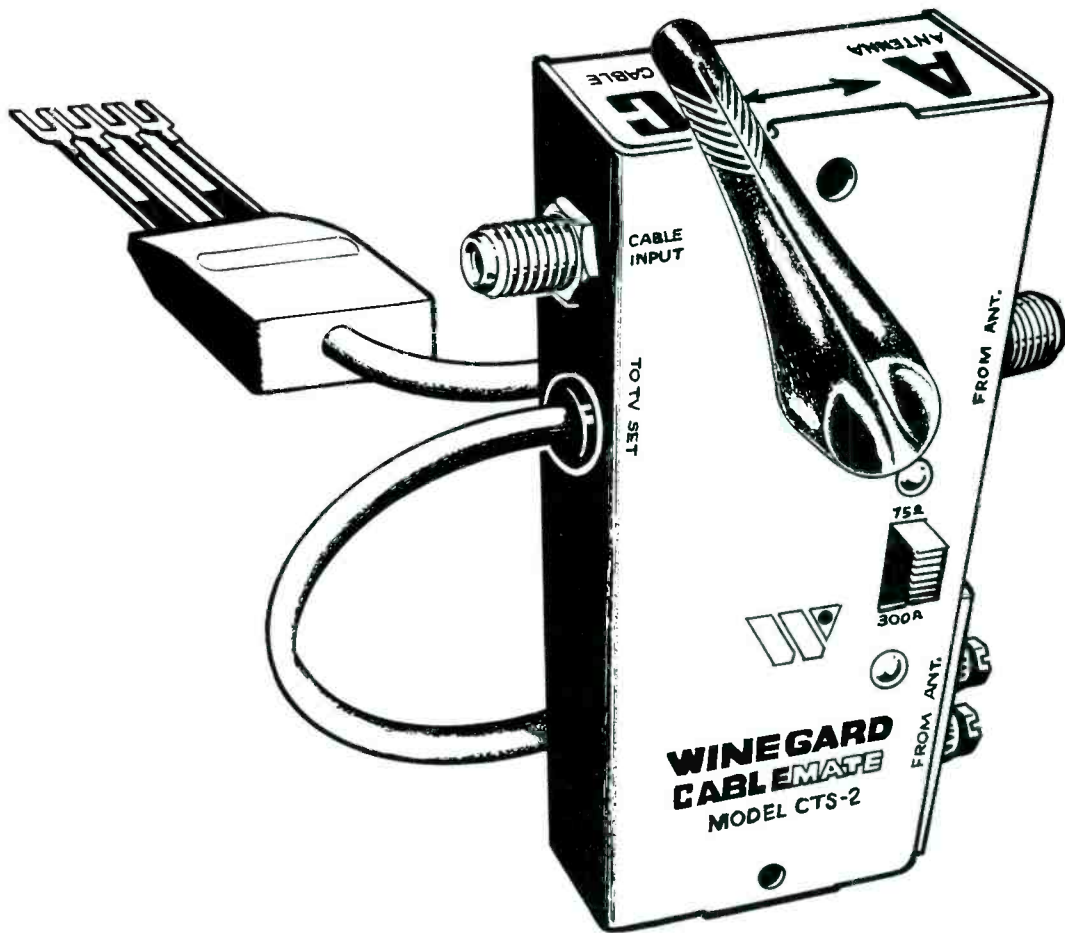

The new exclusive Winegard Cablemate TV Signal Selector lets your customers enjoy the advantages of both cable and TV antenna reception.

If there's cable TV in your area, a lot of your customers already have, or someday will have, a cable hookup. Most of them sign up to get long distance stations or local programming not possible with an outdoor antenna. At the same time, cable people claim that every subscriber will get better reception all the way around.

But the cable subscriber usually gets short-changed. He soon finds out that the channels he regularly watched with an outdoor antenna **don't** come in as clear on cable. And these are almost always the network stations, the ones people watch 90% of the time.

Technicians Frequently Get Blame

The problem of poor quality cable reception on one or more channels is a common one in city after city. Too often the TV technician is called for TV set repair when the cable is really at fault. Cable outages, too, are a frequent customer complaint.

That's where you come in. With a Winegard Cablemate TV Signal Selector and a Winegard outdoor antenna.

Cablemate lets you connect cable signal **and** the antenna signal to the TV receiver. The viewer simply flips a switch to select antenna or cable.

Not "Just Another Switch"

Cablemate, of course, is not an ordinary switch. It has specially designed circuitry with 58db isolation to prevent interference between cable and antenna signals. And it gives you a choice of coax or twinlead antenna input.

Customers Are Waiting For You

If your cable TV customer already has a good antenna on the roof, then all he needs is Cablemate. But if he has an inadequate antenna or none at all, then he's a hot prospect for **both** an antenna and Cablemate. That's profitable business . . . and the easiest way yet to sell a TV antenna to a cable subscriber.

As you can tell, you stand to gain a lot from one switch! But then remember it comes from Winegard, the folks who consistently originate new and better products for the TV service industry.

MODEL CTS-2 (illustrated):

\$16.95 suggested list.

MODEL CTS-1 (same, but has 75 ohm and 300 ohm output to set and does not include coax or band separator): \$14.95 suggested list.



WINEGARD
TELEVISION SYSTEMS

Winegard Company • 3000 Kirkwood Street • Burlington, Iowa 52601

Need a not-available schematic? Need an obsolete part? Have an unusual service problem and want help? Send information and full mailing address to ELECTRONIC SERVICING. Other ES readers should send replies with their offer of help direct to the writer. We reserve the right to edit and print all letters sent to this column. **Let us help one another.**

Needed: Diagram showing voltage analysis for an E. H. Scott radio. It is a 1937 or 1938 model and the serial number is either OO-31, QQ-31, or possibly OQ-31.

J. Taylor Hurst
P. L. Blake Company
P. O. Box 580
Greenwood, Mississippi 38930

Needed: Six 5AXP4 test tubes for our high school electronics classes.

Frank Tokas
Enrico Fermi High School
124 North Maple Street
Enfield, Connecticut 06082

Needed: Schematic and alignment information for a Signal Corps BC-348Q, made by Wells Gardner about 1950. Will pay for copies, or copy and return.

Stan Telson
5612 East Silver Street
Tucson, Arizona 85712

Needed: A magnetic cone-type speaker for a Radiola model 23 receiver. The large air-suspended cone would be preferred. Will pay any reasonable price.

Allen J. Loeb
414 Chestnut Lane
East Meadow, New York 11554

Needed: Circuit diagram for a Hamilton-Floyd radio with no model number. The radio is about a 1928 to 1932 model and is a 2 band, 5 tube receiver. Also need a diagram for a Fairbanks Morse #50 chassis, about 1939, and an oscillator coil for a Philco model 60 (the coil has two center taps). Have old radios, tubes, and diagrams for sale.

Salim E. Farhat, Jr.
Farhat TV Service
806 S. Edgewood Avenue
Jacksonville, Florida 32205

Needed: Tube data for Dynoptimum tube tester model 322A, made by Radio City Product Company, New York.

J. Stadler
131 Ormsby Avenue
Pittsburgh, Pa. 15210

Needed: Schematic for an Englishtown citizens-band solid-state transceiver model JM-209, manufactured in 1966.

Joseph T. Gabus
P.O. Box 70
Downsville, New York 13755

Needed: C-40 tube adapter for B&K CRT tester model 440.

Leroy M. Johnson
585 Deborah Drive
Sidney, Nebraska 69162

Needed: Operating manual and schematic for model 750 Hickok dynamic mutual-conductance tube tester.

George P. Timmons
2039 Ezekiel Avenue
Zion, Illinois 60099

Needed: Schematic or tube listing for Automatic Radio clock radio model 919. Will pay for expenses.

Morris H. Moses
607 Twinbrook Parkway
Rockville, Maryland 20851

Needed: Schematic and operating manual for a Pyramid capacitor-resistor analyzer model CRA-1, about a 1956 model.

Rainbow Electronics
1234 Londonderry Lane
Costa Mesa, California 92626

Needed: Complete set of "Perpetual Trouble Shooters Manuals". Send price and description of condition.

Larry Laduc
484 Arleta Avenue
San Jose, California 95128

For Sale: Some antique and older tubes; also Riders and other service manuals.

Larry Beitman
409 E. Chalmers
Champaign, Illinois 61820

For Sale: Old-type tubes for TV sets or AC/battery radios. Send for a list.

Charles E. Mack
560 E. Anchor Street
Philadelphia, Pennsylvania 19120

For Sale: Old tubes, some in original box, some not. Name tubes needed and reasonable price offer.

Jesse Armstrong
220 Oakdale
Pasadena, Texas 77502

For Sale: Back issues of PF Reporter from November, 1959 to July, 1967.

J. J. Cieresewski
1300 15th Street
Wyandotte, Michigan 48192

For Sale or Trade: Old type radio ballasts, tubes and parts; want test equipment.

Williams Radio & TV Service
106 South Jefferson Street
Lewisburg, West Virginia 24901

□

MAIL COUPON TODAY
Please send me a Jerrold GIFTORAMA Catalog
and one free GIFTORAMA Point.

Name _____

Address _____

City _____ State & Zip _____

Mail to: Jerrold Electronics Corporation
P.O. Box 350 • Horsham, Pa. 19044

ES-5



Professional Antenna Installers...cut yourself in on...

Free Gifts from Jerrold

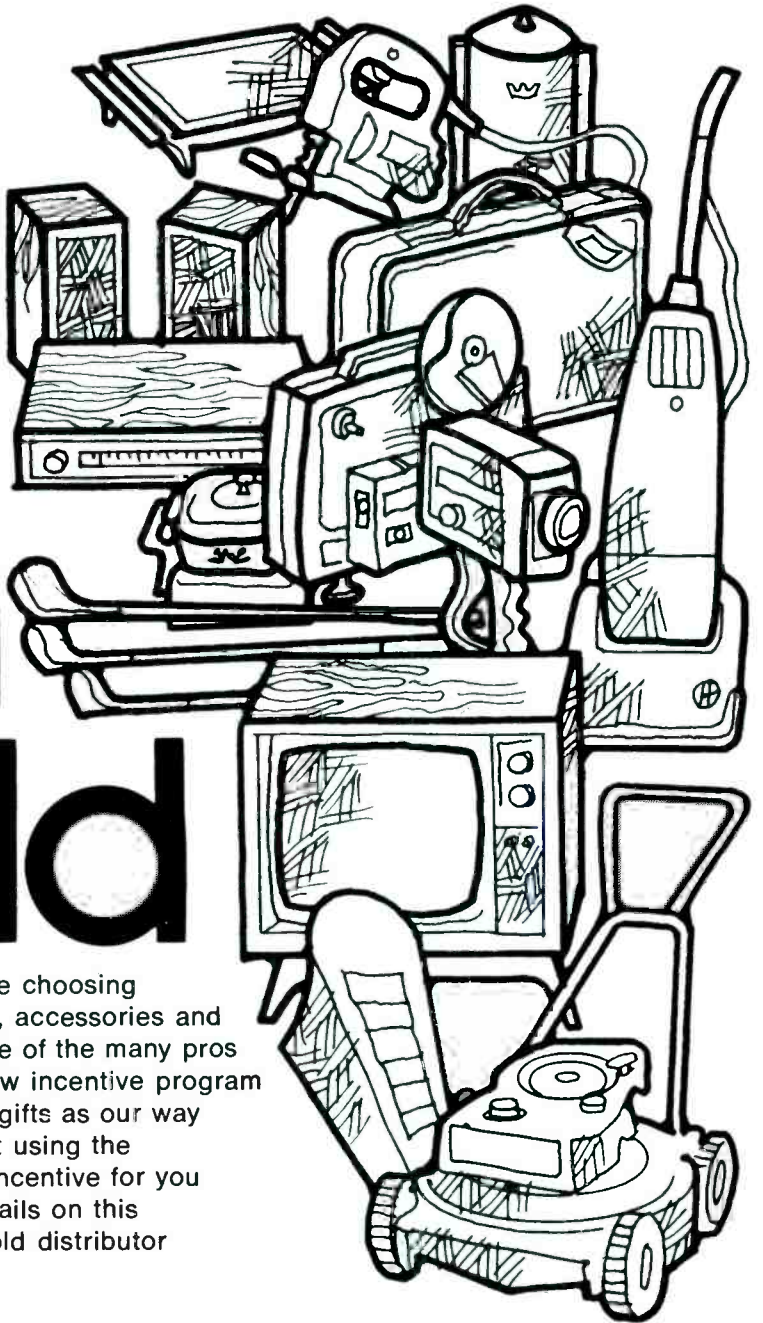

More and more professional installers are choosing Jerrold top-rated antennas, preamplifiers, accessories and INSTANT MATV equipment. If you are one of the many pros using Jerrold equipment, this exciting new incentive program will give you the opportunity to gain free gifts as our way of saying "Thank You." If you are not yet using the Jerrold line, these premium gifts are an incentive for you to try Jerrold products. For complete details on this program, contact your participating Jerrold distributor or mail the above coupon today.



JERROLD

a GENERAL INSTRUMENT company

Electronics Corporation • P.O. Box 350 • Horsham, Pa. 19044

For More Details Circle (26) on Reply Card

A practical way of installing antenna towers

By David A. Ferré

There's good money to be made installing tall towers for the MATV systems of motels, or for homes in fringe areas. These profits should go to you, and not to construction companies.

Follow this ten-step procedure, and without misgivings you can approach your first job of installing a large antenna tower.

The procedure is a practical one, based on knowledge gained from many installations. And it applies equally well to towers of both free-standing and house-bracketed types with heights up to 64 feet.

Preliminaries

A hinged concrete-base type of tower is required, and you should specify this when ordering. Also, consider the need for other items such as rotor posts, accessory plate, or flanges. Lastly, be sure the tower is strong enough for the weight of the antennas it must support. Check with the manufacturer if you have doubts.

Most antennas can be mounted on the tower, and the tower can be

raised, without climbing the tower. That's another advantage of the following method.

Step 1: Tower Inspection

Before the delivery truck leaves, inspect the new tower for damage. Refuse delivery if you find the main struts bent or other damage that would prevent proper installation. However, if some of the lighter cross pieces are bent slightly, you can make repairs by returning them gently to the correct positions.

Step 2: Tower Preparation

Remove the bottom section of the tower and unpack the hinged base that is to be mounted in the concrete. Usually, the instructions say to attach the two together. Remember, two of the legs must act as a hinge, so assemble the parts accordingly.

Test the hinging ability, when you have finished assembling. If each leg has two bolts, hinge on the lower bolt, and temporarily remove the upper bolt. Notice in the photograph how the tower would hinge upward toward the camera, if you removed the upper-hinge leg bolts from the legs at the sides and both bolts from the leg at the rear.

Make sure the pins that are to be embedded in concrete point away from the center, as shown.

Step 3: Form Preparation

A square base form and two tower-support pieces for use while the concrete cures must be made from 2X4 lumber. (If you take reasonable care of them, they can be used over and over.)

Make the base form larger than the size the hole is to be by 4 inches on a side. Dimensions of the hole for the concrete usually are provided by the tower manufacturer. If the figures are not given, use a 3-foot cube for bracketed towers, and a 5-foot cube for free-standing towers.

Two tower-support pieces, made

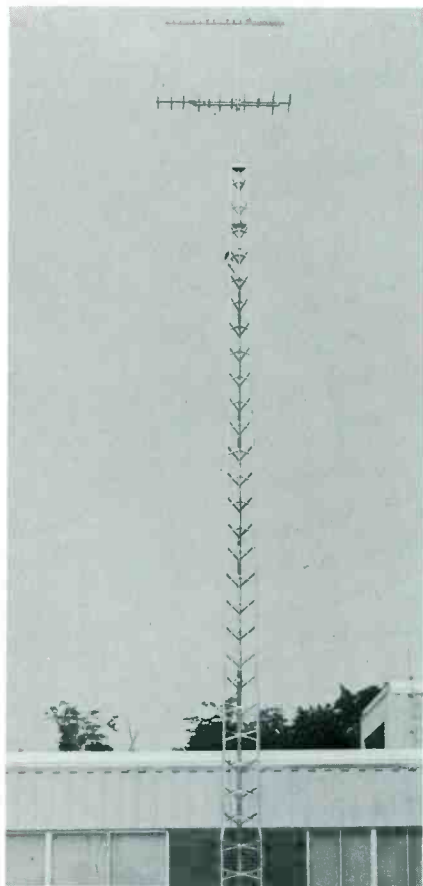

You, too, can install strong and attractive antenna systems at motels, such as this one.



Step 1 Inspect the new tower when first received. Make certain it is the type you ordered, and that it is not damaged.

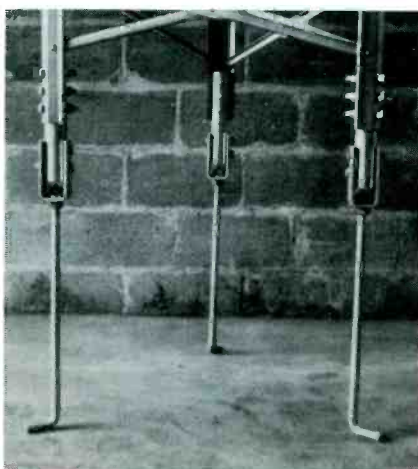

Step 2 Assemble the base section of the tower to see which way the legs hinge. Toes on the pins that go in the concrete should point out as shown.

Look what comes FREE with Sams Photofact® Easy Buy Plans!

In your business the right Photofact Set is almost as essential as the right tools. And Sams Easy Buy Time Payment Plan makes it easy to have the right set when you need it. Just use the Easy Buy Plan to start or to fill out your Photofact library and you'll not only save 55¢ a set, you'll also get a bonus of FREE tools or equipment!

And there's no carrying charge! Fifty-five cents saved on each Photofact Set . . . bought on time without a carrying charge . . . plus FREE tools! It's an offer no TV or radio service shop can afford to pass by. Which of these five great Easy Buy Plans best fits your needs?

Easy Buy Plan #1. Any 60 Photofact Sets you need, for \$20 down, \$145 balance payable without carrying charge. Plus the \$6.15 Xcelite screwdriver/nutdriver set—free!

Easy Buy Plan #2. Any 180 Photofact Sets, for \$20 down, \$475 balance payable without carrying charge. Plus the \$12.40 Xcelite drive socket wrench kit—free!

Easy Buy Plan #3. Any 300 Photofact Sets for \$20 down, \$805 balance, payable without carrying charge. Plus your choice of the \$30 Xcelite #99SM service master tool —or a \$59.95 Craig #2624 portable cassette recorder!

Easy Buy Plan #4. Any 400 Photofact Sets for \$20 down, \$1080 balance payable without carrying charge, plus an \$89.95 Craig #4507 portable electronic calculator—free!

Easy Buy Plan #5. Any 500 Photofact Sets for \$20 down, \$1355 balance payable without carrying charge. Plus your choice of a \$125 Vaco tool luggage case or the \$169 ACT-R 10H/L/U scanner monitor—free!

Free tool/equipment offer expires June 30, 1974.

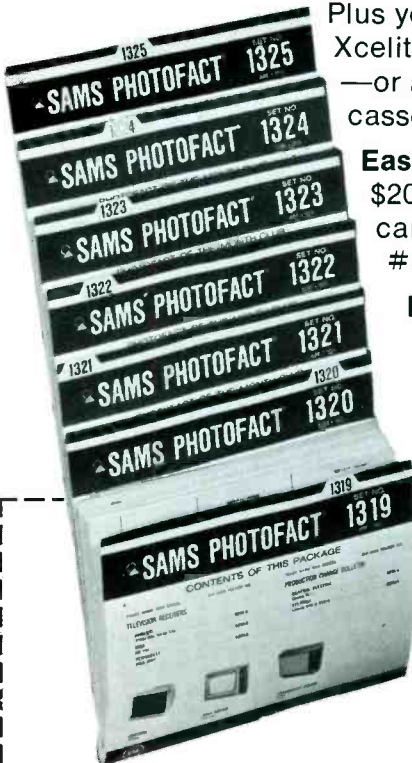

HOWARD W. SAMs & CO., INC.
4300 West 62nd Street, Indianapolis, Indiana 46206

ES 044

I am interested in Easy Buy Plan # _____ Please send me a Photofact purchase contract.

Name _____

Company Name _____

Address _____

City _____ State _____ Zip _____

My Sams Distributor is _____

His Address _____

City _____ State _____ Zip _____

Step 3 Photograph (A) shows how the form will be placed around the hole. Cutaway view at (B) gives details of the base form and the tower-support pieces when individual leg brackets are used. (C) shows the same details when the pins are fastened to a solid base plate.



(A)

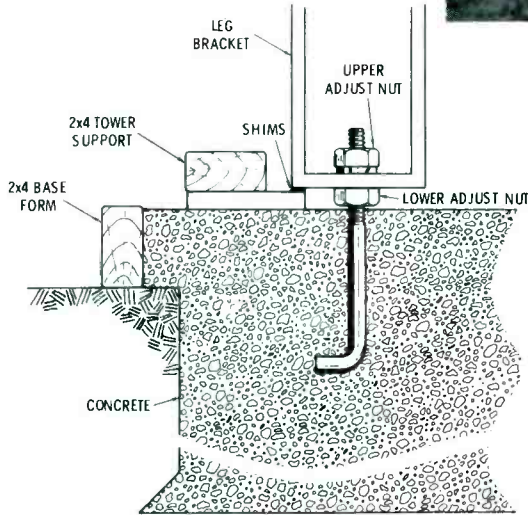

(B)

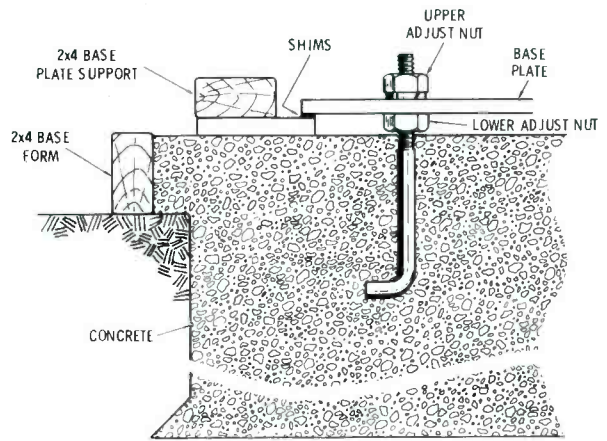

(C)

of 2X4's and 1/2-inch plywood, should be provided to support the tower base while the concrete is hardening. They should be 12-inches longer than the length of one side of the form. Nail a 6-inch width of 1/2-inch plywood to the bottom of each 2X4 so there is a lip on one side. During the tower-leveling adjustments, shims will be placed between the support lip and the tower base to provide accurate leveling.

Step 4: Preparation Of The Site

Because the hole for the concrete base should be reasonably accurate in size and have perpendicular walls, it usually is dug by hand.

Dig the hole to the correct size as given in Step 3. But remember the hole size should be slightly smaller than the base form at the top, and should be 6-inches wider for the bottom one foot.

Important: Don't locate the tower in loose sandy soil, or where there is fresh fill dirt.

Level the base form and nail it to

stakes to prevent shifting during the concrete pour.

Step 5: The Concrete Pour

Perhaps the best and cheapest way to obtain concrete for the tower base is to call a ready-mix company. Tell them the use for the concrete, size of the hole, and when you need delivery. They will follow through.

The hole can be filled with concrete either with the tower base in place or not. If the concrete truck can approach near enough for the spout to reach, it's usually better to have the tower-support boards and the base in position. There's plenty of room for the concrete to enter.

However, if the concrete must be brought in wheelbarrows, have only the square form anchored in position. Then rapidly add the base and the supports before the concrete gets hard to manage.

In either event, fill the concrete to just below the top of the frame, leaving enough space so the tower supports won't indent the surface.



Step 4 The hole for the concrete should be smaller at the top than the inside of the base form. Then the sides should be straight up and down until one foot from the bottom where the hole should be 6-inches wider on each side. To insure accuracy of dimensions, dig the hole by hand rather than using a bulldozer.

THE BIG RIP-OFF

electronic
tube

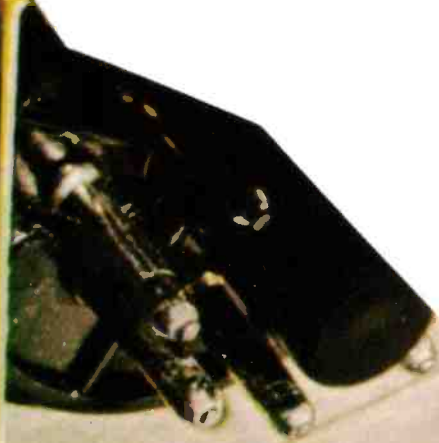



Introducing Sav-

Rip off the tab and earn va

Each Sylvania Entertainment Receiving Tube box features a valuable tab marked "Waltham". Between April 1 and November 30, 1974, you can save them and redeem them for great awards.

There's one tab per box... and you don't have to save a million of them to earn an award. You probably have enough Sylvania Receiving Tubes in your inventory now to earn an award. And the more tubes you buy, the



the Sylvania Sav-a-Tab.

Worked "Waltham"
able awards.

more valuable award you
can earn.
Stop in at your local authorized
Sylvania Distributor and pick up your
free Sylvania Sav-a-Tab Award Catalog, Tab-
Saver Envelope, and Award Order Form today.
Or fill in the handy coupon on the reverse side.
Now, more than ever before, it pays to buy Sylvania
Entertainment Receiving Tubes. And the place to buy
them is your local authorized Sylvania Distributor.



Start ripping tabs off today. Fill in and mail this coupon now.

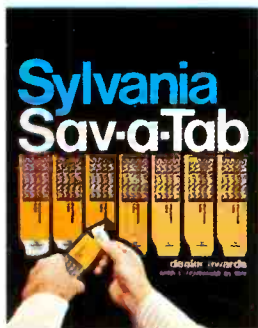

You'll receive this beautiful Sylvania Sav-a-Tab Award Catalog, featuring useful and luxurious name-brand merchandise... everything from a practical tool set to handsome luggage to fabulous weekend holidays!

In addition, we'll send you a Sylvania Tab-Saver Envelope

to collect your "Waltham" Sav-a-Tabs, and a Sylvania Award Order Form. When you've saved the number of tabs necessary for the item of your choice, just drop them in the Tab-Saver Envelope with your Order Form and mail them. Your award will be on the way to you!

If the coupon is missing, circle the Reader Service Number. Or write to: SYLVANIA SAV-A-TAB PROGRAM, Sylvania Award Headquarters, P.O. Box 1000, Fenton, Missouri 63026.

GTE SYLVANIA / Sav-a-Tab

MAIL THIS CARD TO: SYLVANIA AWARD HEADQUARTERS

P.O. Box 1000, Fenton, Missouri 63026

NAME _____

COMPANY _____

ADDRESS _____

CITY _____ STATE _____ ZIP _____



The Sylvania Sav-a-Tab Program is available only to dealers and technicians. Employees of GTE Sylvania, its authorized franchised distributors, or its advertising agency are not eligible to participate.

Add the tower base section and the two tower-support boards, as shown. **Be sure the tower will hinge in the proper direction;** that is, away from the building. This is your last chance to correct any mistakes. After they have been positioned, the tower-support boards should be nailed to the form to prevent any shifting.

Now comes the important job of leveling the base section. This is done with shims placed between the lip of the tower-support boards and the metal tower base. Pieces of old hacksaw blades are excellent shims. Use light hammer taps to lodge the shims into place, and add or subtract shims until the tower section is **absolutely level** on all three legs. Don't rely on later adjustments to correct for any errors in this step.

After the base section is level and the concrete smoothed, don't touch the tower. Add barriers around it to prevent accidental bumps. All will be in vain if the tower is moved. Although the concrete sets in 3 to 8 hours, don't come back to finish the job before waiting three full days.

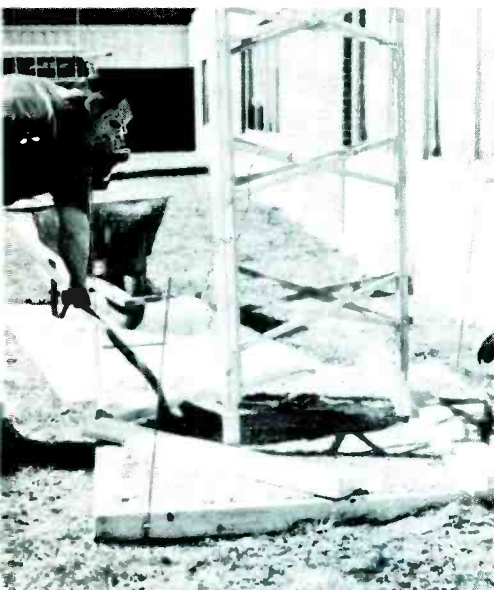

Step 5 If possible, have the ready-mix truck drive in and release the concrete from the spout directly into the hole. Use a wheelbarrow, if that is not possible. Work fast to be sure the concrete is finished on top, and the tower base leveled before the concrete begins to harden.

Step 6: Level Check

After the concrete has cured completely, remove all support pieces and the base form. Re-check the leveling of the tower section. If previous steps have been made correctly, it should be perfectly level. However, if some minor adjustments are necessary, use the upper and lower adjustment nuts.

Step 7: Assemble The Tower

Tilt the base section down by removing the bolts from the third leg (usually the one nearest the building), and the top bolts of the other two legs. The hinge bolts should be snug, not loose. Add the other tower sections, the antenna mast and the antennas with their downlead wires.

Bracketed towers only

Measure the height from the concrete base to the proposed bracket location (usually on the building). If the location is critical, the bracket should be installed before the base. Then, using a plumb bob, determine the base location and install it. By measurement, add enough



Step 6 After the concrete has cured, and before swinging down the base section for assembly of the tower, recheck the levelness. Use the upper and lower adjustment nuts, if necessary, to make it perfectly level.

tower sections as necessary to reach the bracket location. Usually no more than 30 feet of tower should be together at this time.

Hinge the tower upright, and add the hardware to the third leg to support the tower while you fit the bracket into place. Use 3-inch lag bolts to attach the bracket to the building or whatever is used to brace the tower. Be certain the tower sections are level during this procedure.

Because the hinge axis normally is away from the building, the bracket must "reach around" the tower to attach to the hinge-axis side. Be sure to order a bracket large enough to reach.

Remove the least amount of hardware from the bracket which will allow you to tilt the tower down to the ground. Reverse the raising procedure and lower the tower.

Add the remaining sections of the tower, starting at the lower ones. While using a stepladder to support the assembled tower, add the mast, antennas, rotor, cables and all other antenna equipment. **Secure all cables to the third leg of**

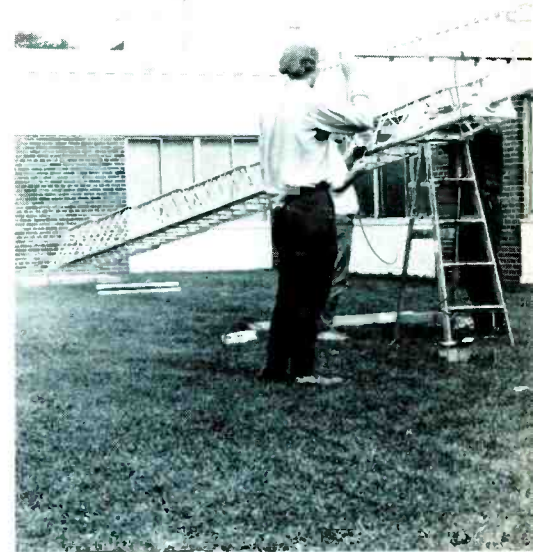

Step 7 Tilt down the base section and assemble the other sections of the tower, plus the antenna mast, the antennas, and the downleads.

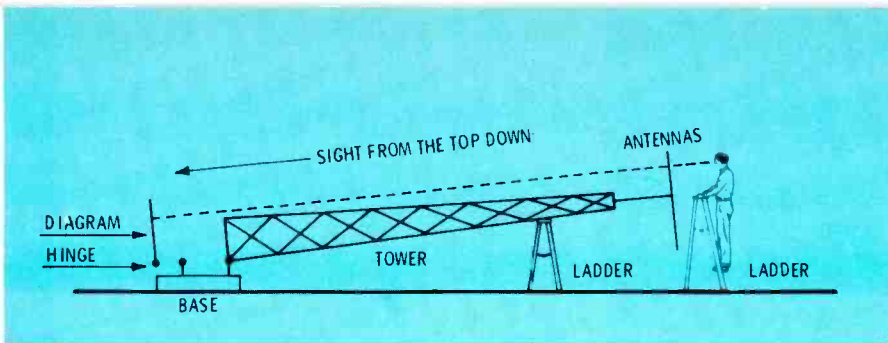

Step 8 Mark a cardboard with the directions all the antennas should point. Orient each antenna before the tower is raised, so it will not be necessary to climb the tower. Use the method given in the text.

the tower, not to either of the two hinged legs.

Step 8: Antenna Alignment

To eliminate climbing the tower for antenna orientation, the antennas must be rotated in the correct directions before the tower is raised. If a rotor is used, this is a simple matter of aiming the antenna north or south, as recommended by the rotor manufacturer. Multiple, fixed antennas are not quite so simple, but they can be oriented without too much trouble.

Cut out a piece of cardboard about 3-feet square. Place this next to the antenna base across from the hinge axis. Using a test antenna and a receiver or field-strength meter, determine the optimum directions the antennas should be pointed. Accuracy is important.

Place a dot in the center of the cardboard and, using a large-tipped marking pen, draw lines from the dot towards the direction the antennas need to be directed. Now, "hinge" the cardboard up, and sight down from the top of the mast to the cardboard while aligning the antennas to correspond to the lines on the cardboard. In most cases, the final results in signal quality from the antennas will be excellent.

Step 9: Before Raising The Tower

Before raising the tower, go over this checklist:

- **All hardware tight?** Check each bolt and nut on tower and antennas.
- **Antennas aimed correctly?** If a rotor is used, be sure you used north or south as specified by the manufacturer.
- **Hinge bolts snug?** Not loose or tight, but snug.

• Hardware ready for tower raising?

Winds should be calm, or at least there should be no side winds. Be sure you have sufficient manpower. **Remember, safety first!**

Essentially, this method calls for raising the tower to about 30 to 45 degrees by people power, or by pushing with a vehicle. Then the antenna mast is pulled by block-and-tackle. Both pushing and pulling action plus slow and careful moves make the operation safe and certain.

People Power

Employ two people for every 10 feet of tower. For example, a 40-foot tower would require 8 people to push.

Buy from a fencing-supply store a 15-foot piece of **heavy gauge** hollow steel fence post of 2-inch

outside diameter.

After Step 8, the top of the tower should be supported by a step-ladder or a truck. With half the men on one end of the post, and half on the other, position the post under the tower and at right angles to it. Then have them lift the post while walking toward the base of the tower. The post slides along the tower as it rises. **Caution:** free-standing towers get wider as you near the base, so don't start with the men too near the center of the post. Watch out for fingers! As soon as possible, use the block-and-tackle to take the load off the pushers.

Of course, vehicle power can be used, as shown in the picture, but don't try to push the tower any farther than where the block-and-tackle can take over the load. Use a piece of pressed wood or plywood to protect the paint of the vehicle. Don't try to use smaller vans, because the roofs pop and cave in from the weight.

Calculating the block-and-tackle

If 8 men are required to push up a 40-foot tower, then without any mechanical leverage, it would still require 8 men on a single rope to pull up the tower. Or four men operating a block-and-tackle with a mechanical advantage of two. Or two men and a block-and-tackle with a mechanical advantage of

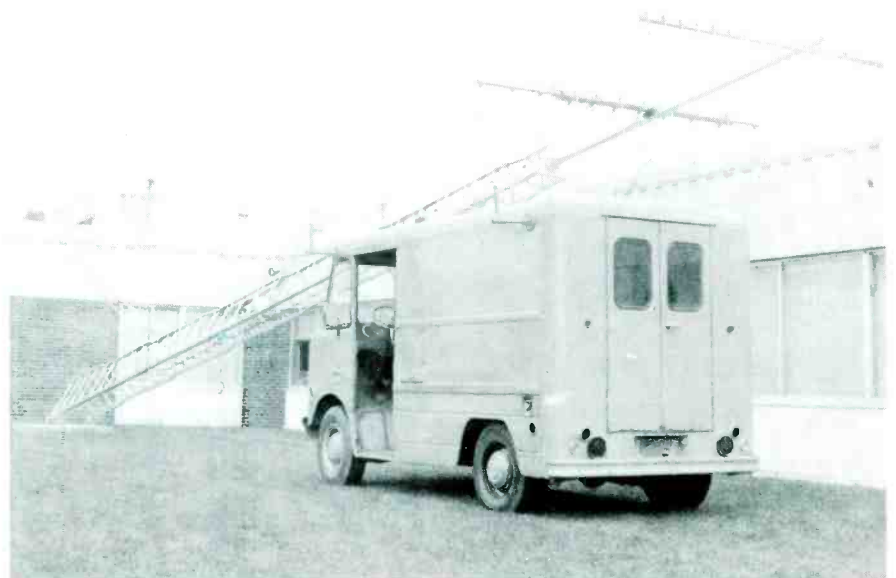

Step 9 Raise the tower to 30 or 45 degrees by using a pole and plenty of manpower, or employ a vehicle which has a strong roof. Pull the tower the remainder of the distance by using a block-and-tackle.

four.

To determine the mechanical advantage of any block-and-tackle, count the number of ropes between the blocks (don't count the pull rope). The number of ropes is the mechanical advantage.

For example, a 50-foot tower requiring 10 men to push it up to 45 degrees, could be raised by a 4-rope block-and-tackle and three men.

Important: For full advantage, the pull rope must come from the block at the **top** of the tower. This poses a question of how to remove the top end of the tackle after you're through, without climbing the tower.

The solution is to attach the block to the tower with a large loop of rope which is long enough to be cut and removed from the ground or a nearby roof top.

Top of the loop of rope should be around a crosspiece about two-thirds of the way up from the bottom of the tower. For example, a 60-foot tower should have the top of the loop at the 40-foot level.

The rigid block should be attached to a tree, car or something else solid and immovable. **Im-**

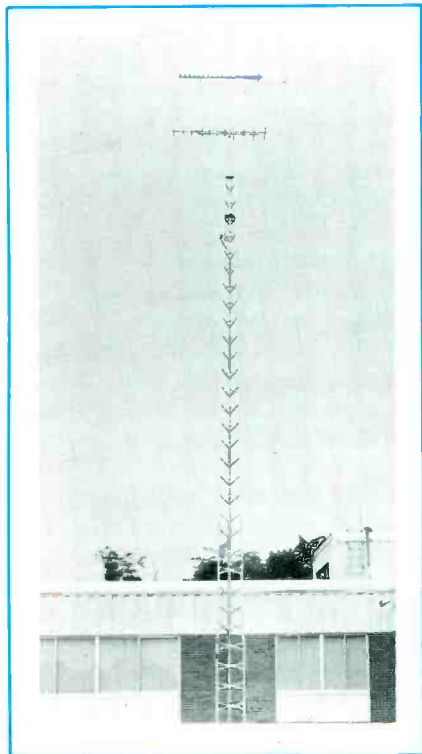

Step 10 After the tower is upright, quickly add all hardware to the base and secure it. Check for levelness, and make sure none of the three pins coming from the concrete has been bent. That's all.

portant: This rigid point **must be in line** horizontally with a sighting from the top of the tower to the center of the base before it is raised. Otherwise the tower might be twisted and possibly ruined during the raising. If the point is far away, another loop of rope can be added at the rigid-block end. This saves using too much rope for the block-and-tackle. (However, make sure the two blocks cannot come together before the tower is completely raised.)

The rigid pulling point should be at least two tower lengths from the base. So, a 40-foot tower should have a rigid point at least 80 feet from the base of the tower.

Raising the tower

Begin pulling with the tackle just as soon as the pushing and raising starts; this takes up the slack. Then at about the 40-degree mark, the tackle has control of the tower.

When the tower reaches the upright position, make sure someone is at the base to guide the tower leg into position.

Ease up on the tackle power when the tower is nearly upright; it's very easy to move in any direction at that time. Don't overshoot and bend the leg.

Sometimes, with free-standing towers, it is possible for the pins that protrude from the concrete to become bent during the raising, especially if the rigid point is not quite straight with the rising path of the tower. During the pouring, keep the pins as low as possible in the concrete to minimize this possibility.

If you notice the pins bending during the raising, don't stop, but proceed until the tower is upright. Then use a pry bar to slowly return the pins to the correct position. **Never** use a hammer to pound them back.

Step 10: Securing The Tower

When the tower is upright, quickly add all hardware to the base to secure the tower. Until this is accomplished, keep light tension on the block-and-tackle rope.

After all is secure, cut the loop of rope at the tower and remove the block-and-tackle.

Again check the tower alignment; then, except for cleanup and checking the reception, **the job is finished.**

Guesswork is gone!...

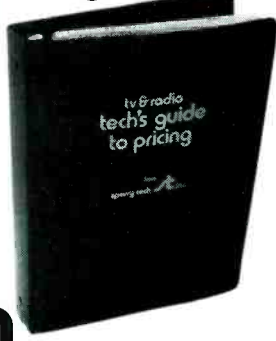

service breakthrough

in flat rate pricing!

Now, for the first time, one compact book guides you through the pricing hazards encountered in today's major categories of TV and radio repair. No more guess work. The building block system automatically provides an accurate pricing method for each step or adjustment involved. Each step is priced according to its complexity or magnitude. Also, there's a bonus section in the book that provides new business planning insight, that gives you an edge in all areas of pricing. **It's simple to use!** 1... index to the product repair. 2... total times for each repair. 3... convert time to price on the calculator page. (converts time to price in any area of the U.S.). Order now! A must for every shop owner... **Don't delay another profit day** simply fill out and mail the coupon below.

\$18⁰⁰ per issue, postpaid.

(Nebr residents add city and state sales tax)

tv & radio tech's guide to pricing

sperry tech inc.
P.O. Box 5234
Lincoln, NE 68505

More information please. My check or money order enclosed.

NAME _____
COMPANY _____
ADDRESS _____
CITY _____ STATE _____ ZIP _____

For More Details Circle (10) on Reply Card



Take a tax deduction for your "Home" office

By Joseph Arkin, CPA

A businessman is entitled legally to a valuable tax deduction, if he uses part of his residence for office work away from his business premises.

Because so many men in business operate this way, the Internal Revenue Service (IRS) has developed a strict set of guidelines for determining the validity and the method of computation of these deductions.

An office at home can be used for bookkeeping, clerical work, or records keeping.

To justify expenses of a home-office, the proprietor or partner might be forced to show the IRS during an audit that the business premises are not appropriate for work that needs to be done after hours. Perhaps the building must be locked during the evening hours because of security problems. If a building is shared with other businesses, there might be no heat or elevator service after normal closing time. Or the space available at work is not sufficient for the extra office equipment. It is not considered valid for a businessman to work at home merely because it's more convenient, or so he might be near his family.

A self-employed person (proprietor or partner) has an advantage in claiming an office-at-home deduction, because, unlike an employee, he can decide whether or not work needs to be done at home.

Employees have different requirements. They must show that having a home-office is necessary to the fulfillment of their regular duties. In case of an audit, an employee should bring a letter from his employer attesting to the facts. Obviously, the company officer who furnishes such a letter to himself as an employee faces the possibility his letter might be considered as self-serving.

To minimize attention of the IRS to the deduction, a proprietor could charge **rent**, and credit **drawing** on the double-entry bookkeeping system.

An employee who doesn't want to deduct the office expense items as a "long-form" deduction can arrange for his employer to pay him an allowance. As in the case of the self-employed, this doesn't raise a red flag automatically on the return filed.

What is an office?

The IRS apparently has no fixed definition of an office in the home. A desk and file cabinet in the corner of a bedroom has been

sustained as a home-office.

Probably the method most immune from challenge is to use a whole room (for example, an unused bedroom) and equip it as an office. There should be office furniture (desk, chairs, and files), a telephone, office equipment (adding machine, typewriter, and check-writer), bookcases for trade or technical books and magazines, and office supplies, such as stationery, envelopes and stamps.

How to figure expenses

Figures for the actual deduction are based on the amount of space allocated for home-office purposes versus the space for living areas. Any method can be used for calculation if it does not differ significantly from a straight percentage based on the areas involved.

Thus, one method compares the number of square feet used for home-office space to the total number of square feet in the residence. Or, if the rooms have basically the same dimensions, the ratio of rooms used for office space compared to the total number of rooms can provide the percentage.

Here is an example typical of an apartment dweller occupying a five-room apartment, with one of the

(Continued on page 53)

The Single Source For Reliable Protection For Every Type Of Electronic And Electrical Circuit And Device

BUSS[®]

SMALL DIMENSION FUSES AND FUSEHOLDERS

Include dual-element "slow-blowing" fuses, single-element "quick-acting" fuses and signal or visual indicating type fuses . . . in sizes from 1/500 amp. up . . . PLUS: a companion line of fuseholders.

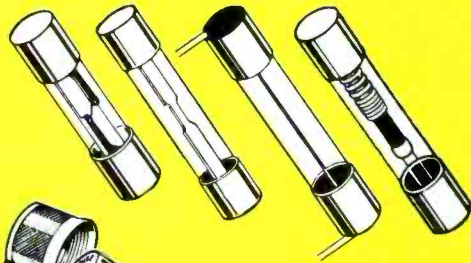

BLOCKS FOR BUSS FUSES

All types available for every application. Single pole, multiple pole, small base, full base, molded base, laminated base, porcelain base for fuses from 1/4 x 5/8 inches up. Also signal fuse blocks and special blocks of all types.

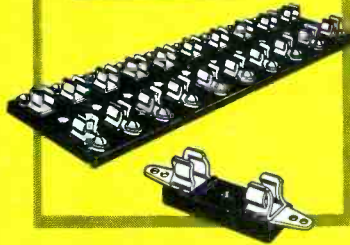

HMR — RF shielded fuseholder for 1/4 x 1 1/4 in. fuses.



HKP panel mounted fuseholder for 1/4 x 1 1/4 in. fuse.

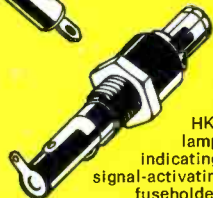

HKA lamp-indicating, signal-activating fuseholder.



TRON[®] Rectifier Fuses For the Safe Protection of Solid State Devices

Provide extremely fast opening on overload and fault currents, with a high degree of restriction of let-thru current. Many types and sizes available. Ampere ratings from 1/2 to 1000 in voltages up to 1500.

BUSS SNAP-LOCK FUSE-HOLDER — Rear panel-mounted fuseholder for 1/4 x 1 1/4" fuses. Snaps into place. Specify HTA-00 for space-saver type, HLD-00 for visual-indicating type, HKP-00 for standard fuseholder, or HJM-00 for 1/4 x 1" fuses.



SUB-MINIATURE FUSE — Ideal for space tight applications, light weight, vibration and shock resistant. For use as part of miniaturized integrated circuit, large multi-circuit electronic systems, computers, printed circuit boards, all electronic circuitry.

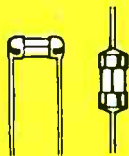

BUSS Sub-Miniature GMW Fuse and HWA Fuseholder. Fuse size only .270 x .250 inches. Fuse has window for visual inspection of element. Fuse may be used with or without holder. 1/200 to 5 amp. Fuses and holders meet Military Specifications.

TRON Sub-Miniature Pigtail Fuses — Body size only .145 x .300 inches. Glass tube construction permits visual inspection of element. Hermetically sealed. Twenty-three ampere sizes from 1/100 thru 15.

THE COMPLETE LINE OF SIGNAL-INDICATING ALARM-ACTIVATING FUSES

For use on computers, microwave units, communication equipment, all electronic circuitry.



BUSS GLD 1/4 x 1 1/4 in. Visual-Indicating, Alarm-Activating.

BUSS GBA 1/4 x 1 1/4 in. Visual-Indicating



BUSS Grasshopper Fuse, Visual-Indicating, Alarm-Activating.



BUSS MIN 13/32 x 1 1/2 in. Visual-Indicating.

BUSS MIC 13/32 x 1 1/2 in. Visual-Indicating, Alarm-Activating.



BUSS ACH Aircraft Limiter, Visual-Indicating.



FNA FUSETRON[®] dual-element Fuse 13/32 x 1 1/2 in. slow-blowing, Visual-Indicating, Alarm-Activating. (Also useful for protection of small motors, solenoids, transformers in machine tool industry.)

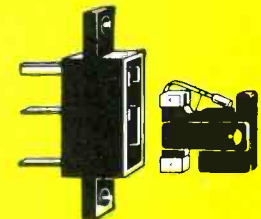

BUSS GMT and HLT holder, Visual-Indicating, Alarm-Activating.

FOR MORE INFORMATION ON THE COMPLETE BUSS LINE, WRITE FOR BUSS FORM SFB.



BUSSMANN MANUFACTURING
a McGraw-Edison Company Division
St. Louis, Missouri 63107



SIGNATURE PATTERNS

Made On Sprague/Jud Williams Model A Curve Tracer

PHILCO-FORD CHASSIS 3CR41

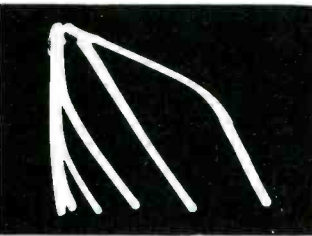
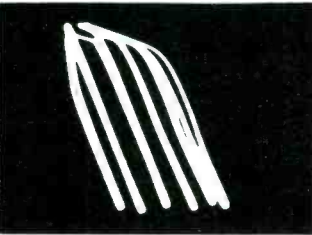
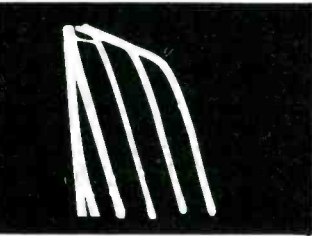
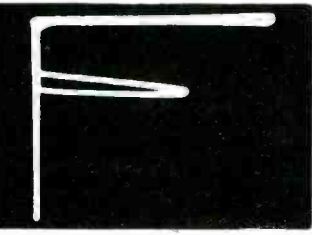
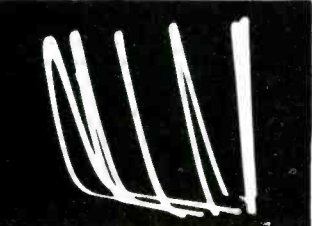
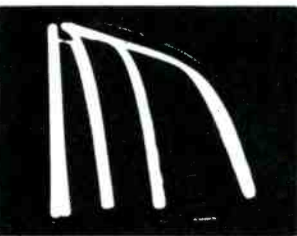
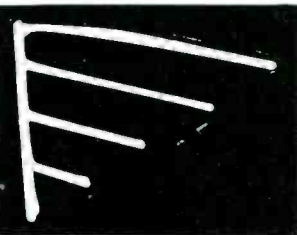
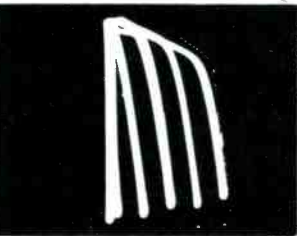
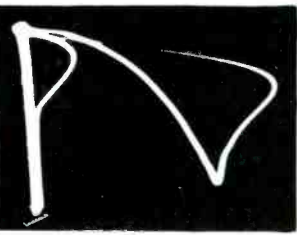
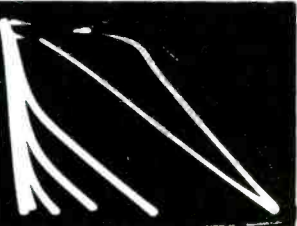
MANUFACTURER PHILCO-FORD		MODEL OR CHASSIS 3CR41	
TRANSISTOR IDENTIFICATION & CURVE TRACER SETTINGS		SIGNATURE PATTERNS	
Q1 1ST IF			
POLARITY	NPN		
SWEEP VOLTAGE	30V		
BASE CURRENT	500 μ A		
Q2 2ND IF			
POLARITY	NPN		
SWEEP VOLTAGE	30V		
BASE CURRENT	50 μ A		
Q3 3RD IF			
POLARITY	NPN		
SWEEP VOLTAGE	30V		
BASE CURRENT	100 μ A		
Q4 AGC KEYING			
POLARITY	NPN		
SWEEP VOLTAGE	30V		
BASE CURRENT	100 μ A		
Q5 RF AGC AMP			
POLARITY	PNP		
SWEEP VOLTAGE	30V		
BASE CURRENT	200 μ A		
Q6 1ST VID AMP			
POLARITY	NPN		
SWEEP VOLTAGE	30V		
BASE CURRENT	200 μ A		
Q41 SYNC SEP			
POLARITY	NPN		
SWEEP VOLTAGE	30V		
BASE CURRENT	20 μ A		
Q91 2ND VID AMP			
POLARITY	NPN		
SWEEP VOLTAGE	30V		
BASE CURRENT	100 μ A		
Q92 COLOR KILLER			
POLARITY	NPN		
SWEEP VOLTAGE	30V		
BASE CURRENT	10 μ A		
Q93 BURST AMP			
POLARITY	NPN		
SWEEP VOLTAGE	30V		
BASE CURRENT	100 μ A		

BEFORE YOU BUY A SWITCH... CONSIDER THIS- ELECTROGRAFT GIVES YOU ...

- More than 120 switches and accessories of all types and styles
- All displayed on one fixture for easy selection
- Also available in bulk put-ups for quantity users.

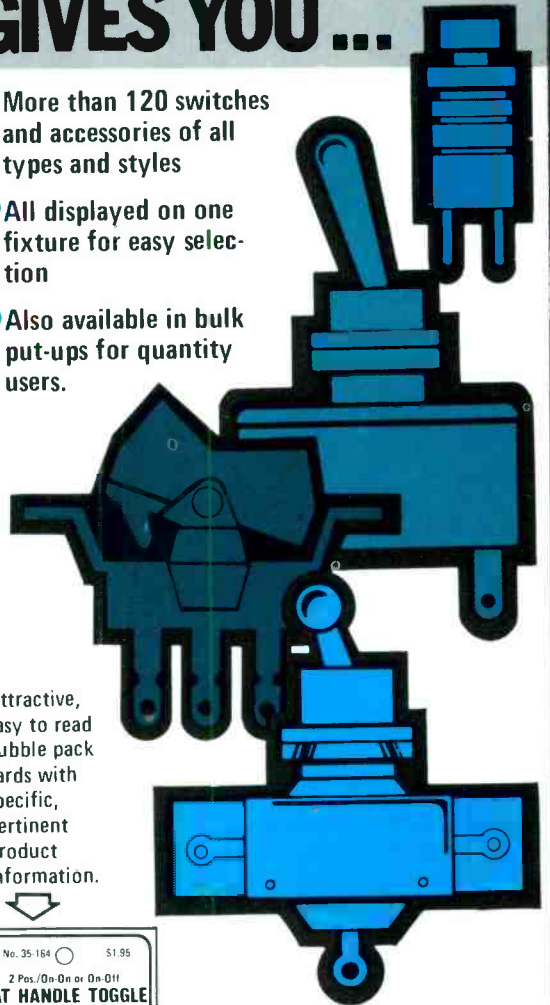

Attractive, easy to read bubble pack cards with specific, pertinent product information.

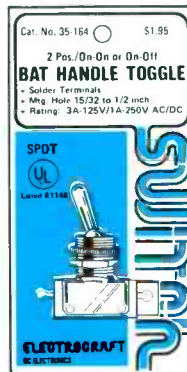

48 page catalog complete with technical specs, templates and cross reference also available

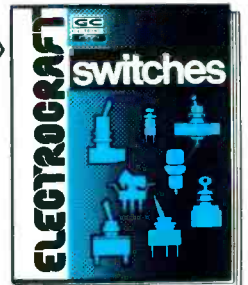

GC ELECTRONICS
DIVISION OF HYDROMETALS, INC.
ROCKFORD, ILLINOIS 61101 U.S.A.



MANUFACTURER PHILCO-FORD	MODEL OR CHASSIS 3CR41
TRANSISTOR IDENTIFICATION & CURVE TRACER SETTINGS	SIGNATURE PATTERNS

Q94 2ND CHROMA AMP	
POLARITY NPN	
SWEEP VOLTAGE 30V	
BASE CURRENT 100 μ A	

Q95 1ST CHROMA AMP	
POLARITY NPN	
SWEEP VOLTAGE 30V	
BASE CURRENT 100 μ A	

Q96 HORIZ BLANKING AMP	
POLARITY NPN	
SWEEP VOLTAGE 30V	
BASE CURRENT 50 μ A	

Q97 COLOR LAMP AMP	
POLARITY PNP	
SWEEP VOLTAGE 30V	
BASE CURRENT 200 μ A	

Q200 REGULATOR	NO SIGNATURE PATTERN
POLARITY NPN	
SWEEP VOLTAGE	
BASE CURRENT	

Q201 AUDIO OUTPUT	
POLARITY NPN	
SWEEP VOLTAGE 30V	
BASE CURRENT 20 μ A	

When is a vertical trouble not a vertical trouble?



Do you know the answer to this problem that apparently has no cause and no normal cure?

By Wayne Lemons

I'm sure you've had weeks when none of the repairs go right. Video troubles turn out to be open resistors in the audio circuit, audio problems originate in the sync stages, AGC troubles start in the horizontal oscillator, and color defects come from the power supply.

These are the kind of troubles a friend of mine calls the "you-step-on-a-cat's-tail-and-he-yells-at-the-other-end" problems. Often the answer seems easy after you finally discover where the defect is hiding.

Take the case of the vertical problem that wasn't a vertical problem. It started innocently enough. A friend, who is a good TV technician, called to ask me to drop by his shop on my way home. "I've got one that will make you a good story," he said. And he was right!

"What's the problem?" I asked.

"It's vertical shimmy, the whole picture moves up and down rapidly."

"Same on all channels?" I asked.

"Varies a bit from time-to-time and from station-to-station, but it's hard to say just what difference there is," he answered.

"What have you checked?"

"I've checked lots of things. And I know how to cure the trouble."

"Then why don't you just fix it and tell me about it?"

"Because I don't know **why** what I did fixed it."

"Okay," I said, "that sounds

interesting. Please explain yourself."

So, he explained the problem. The new color-TV receiver had shimmied when first unpacked in his store. Back at the bench, he tried tracing with a scope (without removing the chassis) and found some small pips that shouldn't be there riding on top of the sync pulses. Unfortunately, that did not explain where they came from.

Other sets nearby were operating normally, and they showed no sign of noise from arcs when the new set was turned on or off. While this test is not proof positive of no arcs, it's a good one.

He decided to pull the tuner and chassis and operate them on the bench for more tests. However, when he did so, the set performed perfectly. He thought of something loose or intermittent, but no amount of jarring would trigger on the trouble. He reinstalled the chassis and tuner in the cabinet and turned it on. Yes, you guessed it! The shimmy was back exactly as before.

To make a long story much shorter, he found after many false starts that the shimmy stopped when he removed the tuner from its mounting. Further experimentation showed that the trouble also stopped if the tuner was correctly mounted but just one of the foil ground strips (the one from the tuner to the picture-tube mounting bracket) was removed.

At this time, he called the regional service manager for that brand and told him the whole story. The service manager hadn't heard of such a problem before and could make no suggestions.

After that he called me. "What am I overlooking?" he asked.

"I'll be by your shop this afternoon," I promised.

The Expert On Trial

"The factory man said maybe the bonding wasn't securely fastened," my friend reported, after I arrived at his shop. "But, I connected my 20-ampere DC power supply between where the bond connects to the tuner and to the chassis. I didn't find one warm spot indicating a bad connection, but my power supply groaned a lot and finally kicked the breaker."

"There's another way to check the grounding," I suggested. "Connect a piece of shield braid as a substitute for the bonding strap."

"I already tried that, and it didn't help the shimmy one bit."

There was another grounding strap connecting the other side of the tuner to the chassis. It almost seemed the designers had a fetish about good grounds. And this is usually an excellent thing.

"Have you tried another tuner?" I asked.

"Yes, but it was a different type of tuner. Shimmy was gone, though."

"Must be in the tuner, then."

"Not necessarily," he said. "I took a tuner of the same type out of another set of a similar model, but the shimmy was still there after I installed the tuner in the cabinet."

"Well, it seems you have touched all bases," I observed.

"I'm afraid so," he said, "that's why I called in an EXPERT."

I felt the gentle little dig when he pronounced "expert" loudly, and with the same accent on both syllables. I was on trial, not the designer or manufacturer. I didn't mind, though. We experts are devious enough to keep from getting cornered. We do this by mumbling a lot and making a few profound statements such as, "Looks like factory trouble to me." Such mis-

directions give a person time to think.

I am forced to end this story as no story has been ended before in this magazine. **We never did find the source of the trouble.** But, it wasn't because we didn't try.

For example, we found the foil could be left connected to the tuner if we removed the clip-on ground wire that went from the metal shield cover of the picture tube to the chassis. Or, we could remove that ground from the shield to chassis, and run the ground instead to the metal yoke mounting without having the shimmy. But, if we ran a ground wire from the yoke mounting to ground after grounding the shield to it, the shimmy returned.

We discovered another interesting fact: If we grounded the picture tube shield from the center to the chassis, there was no shimmy, but if we moved the ground from the right side of the shield to the left side and watched the picture we could see a horizontal shift of the picture. However, with the ground to the center of the shield, there was no shift.

And yet, all these peculiar things happened only if the bond from the tuner to the picture-tube mounting was left connected. Remove that bond and both the shimmy and the picture shift were gone, regardless of where the picture tube was grounded to the chassis.

Perhaps you think it might be a poor AGC bypass? So did we, but neither grounding the AGC terminal on the tuner nor adding a large electrolytic in parallel had any effect. A slight improvement of the shimmy resulted from addition of a large electrolytic bypassing the ATC input at the tuner.

Cure?

Finally, we decided to deliver the receiver with the offending bond missing. No problems have been reported by the customer since that time, so this unorthodox repair must be considered to be effective.

Sequel

A few days later, my friend called to say he had unpacked another

new color set of the same make and model. Sure enough, it had the same shimmy.

"You know what to do this time?" I asked.

"Sure do. Already cut the foil and delivered the set to the customer," he laughed. "Just thought you would like to know where to place the blame."

Yes, I do know who's to blame. But then we have to be somewhat sympathetic. After all, designers have problems, too!

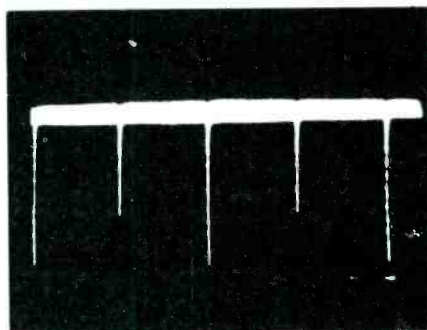

Fig. 1 Horizontal pulses entering the vertical sync partially cancel alternate vertical-sync pulses and cause vertical shimmy.

Editor's note:

Vertical shimmy (that is, rapid up-and-down motion of the entire picture) is caused by horizontal-sweep pulses entering the vertical-oscillator circuit. This has been known to happen when the AGC bypass capacitor to the IF's was open, or as the result of insufficient filtering of the vertical sync pulse in the integrator network. A more rare cause is horizontal pulses from the yoke circuit entering the vertical-sweep circuit via the positive-feedback network when one or more capacitors were open.

Regardless of how the horizontal pulses creep into the vertical oscillator circuit, the result is a partial cancellation of alternate vertical sync pulses. This is possible because of the interlaced-scanning system. One set of vertical-sync pulses occurs near the center of the horizontal-scanning lines (the so-called "hammer" you see when the brightness is high, contrast is low,

and you roll the vertical slowly downward), and this vertical-sync pulse is not affected by intruding horizontal pulses. However, the other set of vertical-sync pulses occurs during horizontal-retrace time. Horizontal pulses added to these vertical-sync pulses (which are actually horizontal pulses of greatly increased width) either add or subtract amplitude, according to the phase. (See the waveform in Figure 1.)

The result is that one vertical-sync pulse is decreased in amplitude, the next is normal, the next is decreased, etc. Therefore, the vertical oscillator starts to roll, then locks on the strong pulse, starts to roll, and locks, etc. The visual effect is a shimmy.

In this true case history, the basic cause undoubtedly was horizontal pulses that interfered with the vertical sync because of a common ground (often called a "ground loop"). The DC high voltage has a lot of ripple in the shape of horizontal-frequency sawteeth, and the picture-tube current must go to ground by way of the conductive aquadag coating on the glass. From the coating, the current goes to the picture-tube shield, then through a metal cabinet or ground strips to the chassis.

Given this type of path, it's easy to imagine the picture-tube current going through the metal strip to the tuner. Then both the pulses of current and the station signal go through the same ground conductor to the chassis. Therefore, the signal is amplitude-modulated by the pulses.

An alternate theory is that pulses from the picture tube go to the tuner, through another conductor to the IF portion of the board, and then might flow through the same wire of the board that also carries the sync signal.

Good design would seem to indicate grounding the picture tube **only** at the high-voltage cage to reduce the possibility of common-ground loops. This same precaution also minimizes failures of solid-state components in case of high-voltage arcs. □

Strange symptoms from "Fail-Safe" circuits part 2

By Lawrence Bowen

Part 1 discussed "hold-down" or redundant circuits that act in case the primary DC-HV regulation is inoperative. This article explains some of the hold-down and disabling circuits used with other types of high-voltage regulators and gives troubleshooting tips.

Pulse Regulators With Hold-Down Circuits

Pulse regulators require less power in normal operation than do HV-DC shunt regulators of the 6BK4 type, and cannot become a source of radiation. For these reasons, several manufacturers have used pulse regulators to replace the older shunt circuits.

The two types have both differences and similarities (see pulse regulator schematic in Figure 1). Both have their cathodes clamped to a B+ source, and both get their control-grid DC voltages through precision voltage dividers from B-boost voltages. Even in the way they obtain bias, they are similar.

But unlike the shunt regulator, whose plate is connected to the DC high-voltage supply of the picture tube, the plate of a pulse regulator is tied to a tap on the flyback transformer. Although B-boost DC voltage is there, the voltage necessary for regulation is the supply of horizontal pulses. Shunt-regulator plate current is DC; pulse-regulator plate current is AC from pulses.

There is one more difference.

Both regulator tubes act as variable resistors. However, an ordinary variable resistor connected across the horizontal pulses would narrow the picture and affect the linearity. This is not acceptable. To eliminate the drawbacks, and yet permit efficient regulation, the pulse tube must be permitted to draw current **only** from the tips of the pulses, the same way the HV-rectifier does. This is done by two actions of the circuit; one is obvious and the other is not.

DC voltage from a divider (R3 and R4) clamps the screen grid to a point far less positive than the cathode. Therefore, regardless of the control-grid bias, there would be no plate current. However, plate current is made possible by posi-

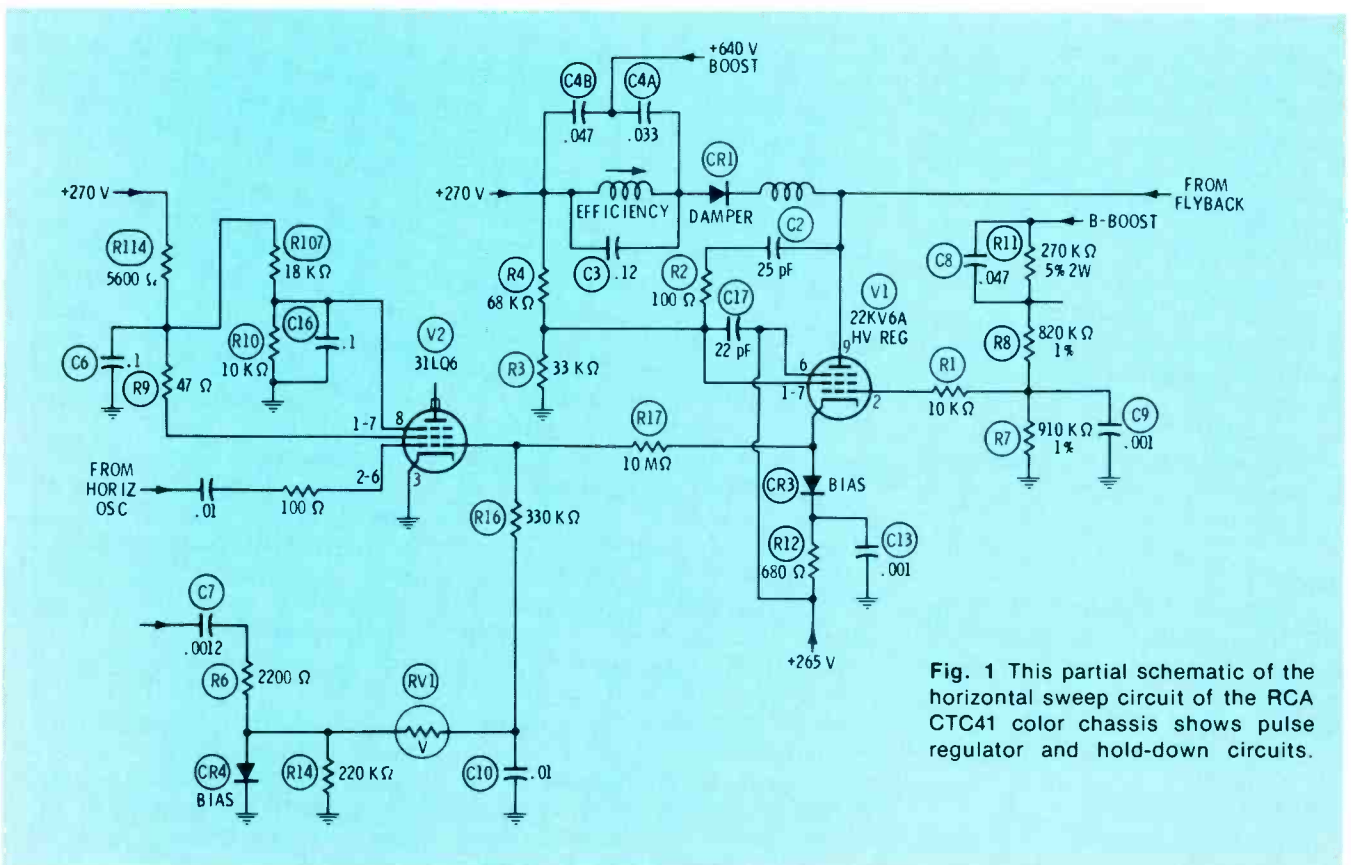

Fig. 1 This partial schematic of the horizontal sweep circuit of the RCA CTC41 color chassis shows pulse regulator and hold-down circuits.

tive-going pulses from the flyback fed to the screen via a capacitance voltage divider (C2 and C17). Plate current flows only when the screen is more positive than the cathode, and this happens at the tips of the pulses.

One additional action narrows the pulses of plate current even more. It's not easy to see because one of the components doesn't show on the schematic. When R1 is added to the control-grid circuit, the impedance is raised enough to form a high-pass filter in conjunction with the internal tube capacitance between screen grid and control grid. The "filter" narrows the pulses obtained from the screen grid and feeds the sharpened pulses to the control grid. The pulses subtract from the cut-off bias, and that's why a normally operating regulator appears to have excessive grid bias. In fact, it's almost impossible to know or measure the true grid bias, because even a lo-cap scope probe loads the circuit and

reduces the amplitude of the pulses at the grid.

The regulator action can be determined by observing how the high voltage fluctuates with different settings of the brightness control.

Troubleshooting tips

Component defects causing the pulse regulator tube to conduct all the time (and not just in pulses) can narrow the picture, particularly on the left edge of the screen. A short-cut test is to ground the grid of the pulse regulator. If the picture improves greatly, there's a good chance the regulator is at fault.

Leakage in C2, an open C17, increased resistance of R1, open R7, decreased value of R4, or an increased or open R3 might cause a narrow picture.

Hold-down circuits

RCA CTC41, CTC42 and CTC43 chassis have pulse regulators plus two kinds of hold-down circuits.

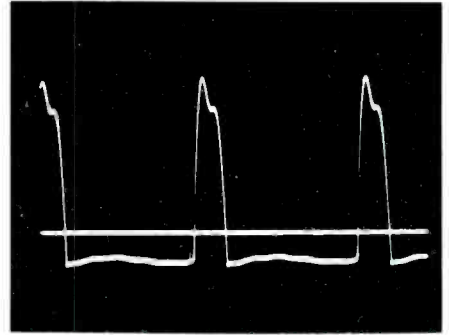

Fig. 3 When the waveform applied to a varistor consists of pulses, the varistor decreases resistance most at the tips of the pulses. This simulates the action of an inefficient diode, and a DC voltage is produced. Symmetrical waveforms don't permit any DC to be generated.

Both are similar to circuits explained in Part 1. CR3 monitors the cathode current of the pulse regulator. If regulator current stops, grid bias for the horizontal-output tube goes much more negative, and this limits the power to the deflection system.

Redundant regulation also is used. CR4 shunt rectifies the horizontal pulses to produce negative voltage. Varistor RV1 passes more of any change of the negative voltage on to the grid of the output tube. Therefore, an increase of the horizontal pulses from the flyback (because of excessive high voltage) causes an increased negative voltage at the grid of the output tube. Any increase of negative grid voltage brought about by adding an external negative voltage decreases the maximum plate current of the output tube, reducing the high voltage.

Regulation By Grid Voltage

Both the DC-shunt and the pulse regulators share one disadvantage: They dissipate power which has been generated by the horizontal-sweep circuit. As a means of conserving this power, many of the newer tube-type sets regulate the high voltage almost solely by adjustment of the grid bias of the output tube. We have already discussed how this works as secondary regulation. When it becomes the primary regulation, another method of redundant regulation must be used.

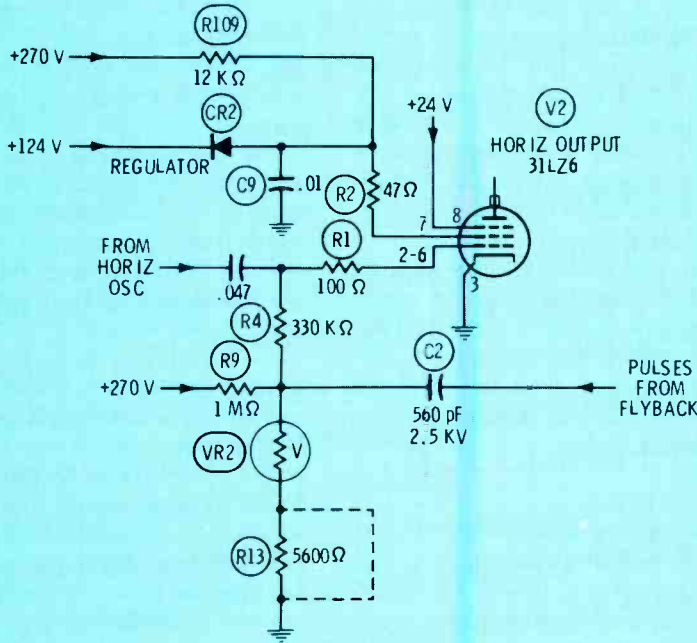

Fig. 2 Early-production CTC51 RCA chassis use a VDR to supply the negative voltage needed for high-voltage regulation. The hold-down action is found in the screen-grid circuit.

In the schematic of Figure 2, the main HV regulation is accomplished by C2, VR2 varistor, and R9. The circuit is similar to one discussed last month, although a diode was used in that one instead of the varistor.

Can a varistor rectify?

Before going on, let's try to settle a minor debate touched off by an article in **ELECTRONIC SERVICING** for November, 1971 on page 17. A portion of the article was devoted to analyzing the response of varistors (voltage-dependent resistors, or VDR's) to various DC currents and voltages, and AC voltages of both sine and pulse waveforms. If you keep a file of back issues, you might want to review the entire article; it's still relevant.

A varistor decreases resistance when the voltage across it is increased. This is true for both DC and AC voltages. The resistance is identical when measured with equal positive or negative voltages; there is no diode effect. **However, under the proper conditions, a varistor used in a rectifier circuit produces DC voltage.** Such a statement makes no sense unless you follow the explanation given next.

Imagine that in Figure 2 the waveform applied to C2 is a sine wave of horizontal-sweep frequency. Notice that a positive voltage is brought in through R9, so at the junction of C2 and the varistor appear both DC and AC voltages. If the amplitude of the sine wave is increased, the resistance of the varistor decreases. Because of resistive voltage divider action, the positive voltage there also decreases. Therefore, changing the AC voltage also changes the DC voltages.

The preceding example was a hypothetical case containing two wrong factors. First, the output DC with varying AC would be a varying positive voltage, whereas a varying negative voltage is needed to properly control the grid bias of the horizontal output tube. Also in the actual circuit, the AC signal consists of positive-going horizontal pulses, not sine waves. The different waveform changes the re-

Figure 3 shows horizontal pulses and the correct zero-voltage line (made from a scope by double-exposure photography). When supplied with that waveform, the varistor decreases resistance only during the time of the positive tips. Between pulses, the resistance increases. The change of resistance is not so large as with a diode, but it is enough to produce in this shunt-rectifier circuit a negative voltage generated at the junction of C2 and VR2. A positive voltage through R9 is provided to cancel most of the normal negative voltage from the "rectification". In this way, a small difference in the amplitude of the pulses makes a larger difference in the negative voltage from the regulator circuit.

By disconnecting R9 and R4, and measuring the DC voltage with the set operating, you can prove to yourself that negative DC actually is generated. Although a varistor under the special conditions found here produces a DC voltage, the amount of voltage is much less than that obtained in the same circuit by substituting a diode for a varistor. Therefore, don't try to substitute a diode for a varistor in these circuits. Varistors are specified because they are not so prone to damage by arcs, as diodes are. **A diode used to replace a varistor would produce excessive negative voltage, causing a narrow picture and reduced high voltage.**

One other point: To obtain a positive DC voltage from such a circuit, it's necessary for the waveform to have **negative-going** pulses. With varistors, the polarity of DC voltage obtained is determined by the polarity of the applied pulses; the varistor, unlike a diode, has no polarity.

HV regulation by bias change

If the negative grid voltage of the horizontal-output tube is increased by an external negative voltage, the sweep is weakened more than by an equal change of DC voltage caused by a different amount of drive from the oscillator.

Look at it this way: The amount of negative grid voltage (when there is no bias regulation circuit) de-

pends solely on the amplitude of drive from the oscillator. Whether the drive is large or small, the grid must be driven slightly positive so grid current flows. Maximum plate current flows during the time the grid is positive. If a negative voltage is brought in from an outside source to increase the grid bias, the grid never becomes positive, and maximum plate current cannot flow.

When the plate current is decreased, there is less width and the HV is reduced. The two go hand in hand, except that the usual slight narrowing at high brightness is partially offset by the slight increase of width occurring when the high voltage is decreased, and the regulation permits the output tube to draw more current.

Another factor preventing the width from changing noticeably is that the amount of bias variation must be restricted to avoid linearity changes. This makes bias-type HV regulation less effective than shunt systems.

A resistor (R13 in series with the varistor) can give a two-step control of high voltage. The HV is about 5% lower with R13 shorted. However, don't remove the jumper to increase the high voltage until you know the circuit is free from defects. For example, if you clip the jumper to compensate for abnormally-low line voltage, the high voltage will become excessive if the set subsequently is operated from normal line voltage.

Troubleshooting wrong high voltage

Excessive high voltage in sets having this circuit is likely to be the result of a failure in the regulator itself. In other words, the grid bias would be not sufficiently negative, causing too much plate current. Leakage in C2 or an open varistor are two possibilities.

At the other extreme, a grid voltage that is too negative causes a small picture, perhaps with poor focus. An increased value or open R9 or R4 are two parts failures which might cause those symptoms.

Hold-Down With Bias Regulation

Most DC-shunt and pulse regulation circuits have an emergency hold-down circuit that overbiases the horizontal output tube. When bias variation is the main source of regulation, some other circuit must be used for hold-down.

In the schematic of Figure 2, the hold-down is in the screen-grid circuit.

Horizontal-output tubes that obtain their screen-grid voltage through a resistor of several thousand ohms have a built-in, but invisible, kind of regulation. When the plate draws more current, the screen-grid voltage rises; this tends to further increase the plate current, which additionally increases the screen-grid voltage, and so on. The purpose of the circuit to be described next is to prevent the screen voltage from rising above a certain value, while allowing it to drop if the conditions demand.

One-way screen-voltage changes

Assume the brightness has been turned down, and there is no defect in the sweep and HV circuits (Figure 2). Control-grid bias will be perhaps 10 volts more negative than at normal brightness. This causes the screen grid to draw less current, and the screen voltage tries to rise. However, when it increases to 124.7 (124-volt supply plus .7 volt drop across CR2), the diode CR2 conducts and clamps the voltage to that value. Thus the screen-grid voltage is prevented from rising. Any voltage above 124.7 coming from R109 flows through CR2 back to the 124-volt supply. This ceiling on the screen voltage adds to the effectiveness of the grid-bias regulation, because the screen voltage can't rise and thus increase the plate current which has been reduced by the higher negative grid bias.

On the other hand, suppose the grid bias becomes too low, perhaps because of insufficient drive or a gassy output tube. Screen current increases (more drop across R109) and the screen voltage begins to decrease. When it drops below 124.7 volts, CR2 is reverse biased

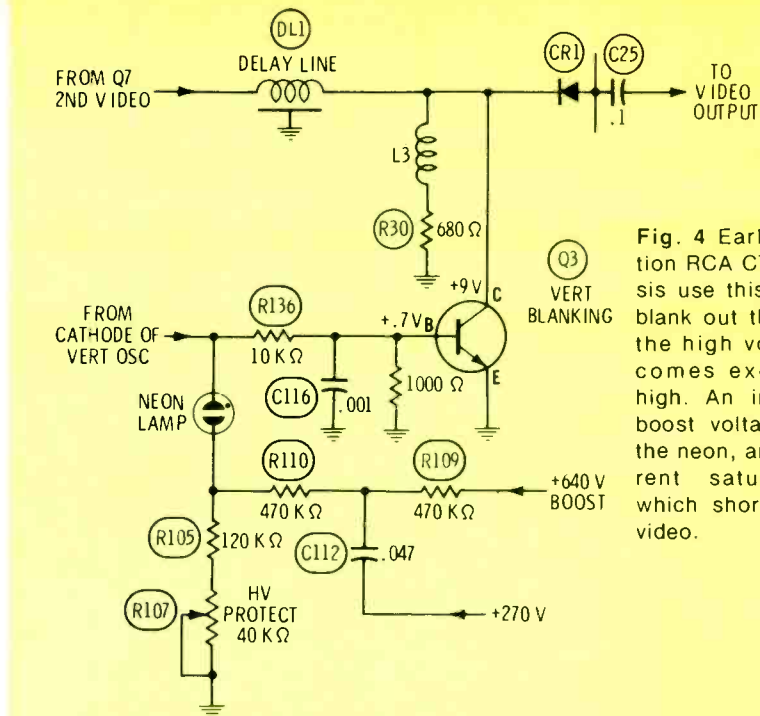

Fig. 4 Early-production RCA CTC63 chassis use this circuit to blank out the video if the high voltage becomes excessively high. An increase of boost voltage ionizes the neon, and the current saturates Q3 which shorts out the video.

and becomes open. The screen voltage no longer is clamped to the 124 volt supply and drops to whatever value is determined by R109 and the screen current.

A secondary effect of this circuit is that the output tube does not "self destruct" as rapidly as would be the case if the screen supply had better regulation.

To sum it up, a screen voltage with a ceiling but no floor helps the HV regulation while continuing to protect the output tube.

Failures of CR2 are a little tricky to diagnose. If it opens, the screen voltage might increase above 124 volts and slightly raise the high voltage. If CR2 shorts, there will be no symptoms or change of operation unless a serious loss of grid drive occurs. In that case, the output tube will fail very rapidly. Because the symptoms of either failure are obscure, it's advisable to check the diode each time you service the horizontal sweep.

Disabling Circuits

All the circuits discussed so far act to limit the high voltage if the primary regulator fails. A few receivers have circuits designed to make the receiver unusable if the high voltage becomes excessive. These circuits do not prevent excessive HV, but they discourage the owner from operating the receiver

until repairs are made.

Video blanking

One method used in the early-production RCA CTC63 chassis was to blank out the video when the high voltage was too high (Figure 4).

If the high voltage is normal, the vertical-blanking transistor (Q3) serves to blank the vertical-retrace lines. In fact, a similar circuit without the video blanking is used in late-production CTC51, CTC52 and CTC53 chassis.

During retrace, current from the cathode of the vertical oscillator flows through the base/emitter junction of Q3 (and through the base resistor). At that time, Q3 is biased into saturation, and the collector grounds the delay line, removing the video and darkening the raster. This is normal retrace blanking.

To blank out the video when the HV is excessive, it is necessary only to feed a steady current to the base of Q3 so it remains saturated.

When the HV is normal, voltage from B-boost via R109, R110, R105, and the HV Protect control, R107, is applied to the neon lamp. But the voltage is not sufficient to ionize the neon. Therefore, no current from the neon lamp gets to Q3; the circuit accomplishes only vertical blanking.

But if the B-boost supply voltage rises because of excessive high voltage (and the HV Protect control is correctly adjusted), the extra voltage ionizes the neon bulb, and the current saturates Q3 which shorts out the video. Because there is no picture, the customer is likely to call for service. Then the technician must determine whether the blunker or a true video trouble is responsible.

One fast test is to ground the base of Q3. If the video is restored, that's proof a defect exists in the high voltage or the protective circuit. Of course, if Q3 has a collector/emitter short, this test proves nothing. Disconnecting the collector would be the next step.

An open base/emitter junction might increase the resistance of the oscillator cathode circuit enough to interfere with vertical sweep. Again, grounding the base is a good test. If it helps the vertical height, the junction is open.

If the collector is open, there will be no symptoms, except perhaps retrace lines on some scenes of the picture. An open collector or open neon lamp prevent blanking of the video when the HV is excessive. Of course, the symptoms are no video and a dim raster if the neon shorts.

Testing the video blanking

The HV Protect control (R107) was factory adjusted and sealed. So, the adjustment cannot be changed to test the circuit. Instead, parallel R109 and R110 with a 4.7-megohm resistor. The neon lamp should glow and the video should disappear. Then remove the resistor and try a 10-megohm value. The lamp should not light. If either condition cannot be realized, probably one of the components in the lamp circuit is defective. In case the lamp, resistors, or the control requires replacement, test with the two values of resistors temporarily connected to determine the correct setting of R107. If you replace R107, seal it with cement after adjustment.

Vertical Disabling

Another method of disabling the receiver is found in the RCA CTC66 and late-production CTC63 chassis (Figure 5). In these sets, the vertical height is collapsed or the

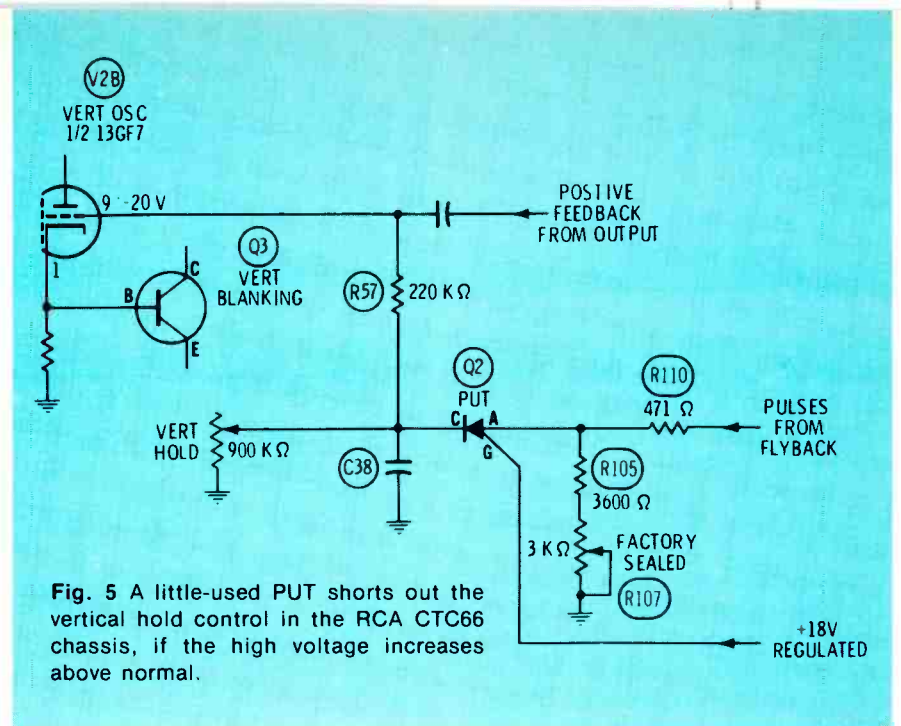

Fig. 5 A little-used PUT shorts out the vertical hold control in the RCA CTC66 chassis, if the high voltage increases above normal.

sweep thrown out of lock.

Before looking at the entire schematic, notice the component marked Q2. It seems similar to an SCR or a triac, but internally the gate operates in conjunction with the anode, instead of the cathode as in the case of an SCR. This device is called a "programmable unijunction transistor", or PUT for short. Like SCR's they continue to conduct after they are gated on until the anode/cathode current drops below the latching minimum. Opposite to SCR's, PUT's require a gate voltage negative to the anode to turn it on.

Once we are over the PUT roadblock, the rest of the circuit is not complicated. Positive-going horizontal pulses are applied to the anode. The gate is connected to the +18-volt supply, and when the HV is not excessive, the anode pulses are not strong enough to make the anode positive relative to the gate. Therefore, the PUT does not conduct. It is an open circuit which doesn't interfere with the normal operation of the vertical-hold control.

But if the high voltage and the horizontal pulses increase too much, the anode of the PUT becomes more positive than its gate, causing conduction between cathode and anode. This connects the vertical hold control to the anode of the PUT. Because the anode can never be more than 6,600 ohms from ground, the vertical-hold control is virtually shorted out and

ineffective. The vertical cannot be locked. What's more, the sweep sometimes collapses leaving only a horizontal line.

Turning off the power, then after a time for cooling, turning it on again permits the PUT to become an open circuit. If the HV malfunction was only temporary, this restores the receiver to normal operation. But if the defect remains, the vertical will be abnormal again after warmup.

As you can see, the disable circuit is a possible source of vertical problems. If the high voltage is not above 25 kV with a black raster and the line voltage not in excess of 120 volts, but the vertical won't lock, the disable circuit should be suspected. Disconnect the cathode of the PUT from the hold control. If this clears the vertical trouble, start checking the parts in the disable circuit. Should none of them appear to be bad, install a new PUT.

Check operation of the disable function by paralleling a 220K resistor across R110. This should cause either vertical roll or a loss of vertical sweep, but a 270K resistor should not.

Because R107, the disable control, is factory set and sealed, it must be replaced if the test conditions indicate the need for adjustment, or if some of the nearby components are off tolerance. After replacement of R107, adjust it so the vertical is barely stable with a 270K resistor paralleled across

R110, and then seal the new pot using epoxy glue.

Summary

In these two articles, we have examined several auxiliary circuits used either to prevent or to announce the generation of excessive high voltage. All the circuits have one thing in common: when the high voltage is normal, they don't "do" anything. Only when the high voltage rises to excessive levels should these circuits perform their intended functions.

If the auxiliary circuit is of the hold-down type, it's likely the viewer will not notice any adverse symptoms, and the problem will continue until another failure makes repairs mandatory.

More misleading are the symptoms, seemingly unrelated to high voltage, produced when the disabling circuits function. For example, there is no logical reason to suspect the high voltage if the vertical is collapsed or cannot be locked, or if there is no video. Some solid-state receivers (not discussed here) even throw the horizontal out of lock when high voltage is excessive.

The first step in diagnosing these problems is to know that the receiver contains such disabling circuits. One way is to examine the schematic of the general area indicated by the prime symptom (video amplifier, for example) to see if there are components without any obvious function. Next, trace to determine if these extra parts tie

into the high-voltage system (probably to B-boost or to the flyback). Finally, measure the high voltage, and make repairs if it is too high. Restoration to normal operation proves the excessive high voltage was triggering the disabling circuit.

If the high voltage is not excessive, there are two general possibilities. Either the disabling circuit itself is defective, or there is a conventional trouble in the circuit indicated by the prime symptoms. In most cases, the disabling circuit can be defeated easily. Normal operation then means the disabling circuit is defective. Ohmmeter tests are often the most effective way of finding defective components in disabling circuits. □

Table 2
Corrected and updated from page 41 of November, 1973
Often-Needed Transistors And Diodes For Servicing Auto Sound

Use	Type Code	Case Style	Delco	GE	IR	Motorola	RCA	Sylvania
AM: RF, IF and conv	PG	DS-25	GE-1	TR-05	HEP254	SK3008	ECG100
	NS	DS-72	GE-17	TR-22	HEP56	SK3005	ECG107
FM: RF, osc and mixer	PG	DS-41	GE-9	TR-12	HEP3	SK3006	ECG126
	NS	DS-74	GE-11	TR-21	HEP56	SK3018	ECG107
FM: IF	PG	DS-81	SK3039	ECG108
	NS	DS-56	GE-9	TR-12	HEP3	SK3006	ECG126
	NS	DS-71	GE-17	TR-21	HEP53	SK3018	ECG107
Audio driver and preamp	PG	DS-72	HEP56	SK3039	ECG108
	NS	DS-26	GE-2	TR-05	HEP254	SK3004	ECG102A
	NS	HEP632
Audio output	PG	T0-3	DS-46	GE-17	TR-24	HEP54	SK3020	ECG123A
	PG	T0-36	DS-66	HEP736	SK3122
Motor regulators	PG	T0-3	DS-503	GE-3	TR-01	HEP232	SK3009	ECG121
	PG	T0-36	DS-520
	NG	T0-66	DS-501	GE-4	TR-03	HEP231	SK3012	ECG105
	NS	plastic	DS-525	HEP233
	PG	T0-66	(Replaces Philco plastic)	ECG155
	PG	T0-66	GE-30	IRTR-55	HEP245*	SK3041	ECG152
	PG	almost T0-66	(Replaces Sanyo 2SB474)	IRTR-50	IRTR-94M	HEP642	SK3052	ECG131
AM detector and AGC diode	NS	T0-66	TR-23	HEP241	SK3026	ECG175
	NS	T0-3	GE-19	TR-26	HEP247	SK3027	ECG130
	NS	T0-3	DS-509	GE-19	TR-26	HEP247	SK3027	ECG130
	NS	P-66 plastic	IRTR-55	HEP245*	SK3041	ECG152
8-volt zener	PS	P-66 plastic	IRTR-56	HEPS007*	SK3083	ECG185
	G	DS-27	1N34AS	HEP134	SK3087	ECG109
AFC diode	S	DS-49	HEPZ0410	SK3059	ECG138
	S	DS-149	HEPZ0411
Dual-gate MOSFET	S	DS-55	SK3126
	S	HEPF2004	SK3050

Type Codes: P - PNP, N - NPN, G - Germanium, S - Silicon, * - Case Difference

Servicing electronic calculators

part 2

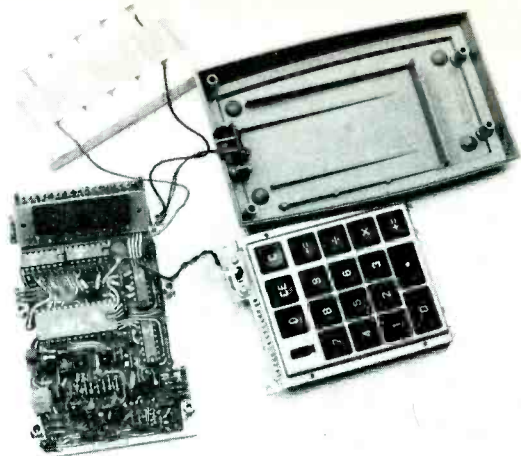

View of a typical 4-function calculator after disassembly.

By Joseph J. Carr, CET

Circuit explanations and methods of repairing calculators are presented in this final article.

A special-purpose MSI (medium-scale integration) calculator-on-a-chip integrated circuit is the heart of any four-function electronic calculator (see the block diagram in Figure 1). Typically, this IC is in a 24-pin D.I.P. package, and is several times larger than the usual 14-pin types commonly found in TV and stereo equipment. Figure 2 shows the base diagram and pin outputs for one of the popular calculator IC's, the Texas Instruments TMS0100NC.

Keyboard Circuitry

Most portable calculators use one of several brands of keyboards having the same general format. After all, they must work with the same type of IC's.

Wiring of a typical keyboard is shown in Figure 3. It consists of a 4-by-11 matrix connected to the calculator IC. In use, for example, the number "3" is entered by the operator pressing the button with the symbol "3". This shorts together the KN bus and the D3 bus. Logic gating inside the IC then enters the digit "3".

Note that each keyboard switch closing connects together a unique combination of bus connections.

The Clock

A clock is used to drive the timing circuits of the main calculator IC and to multiplex the display on and off. Don't let the word "clock" throw you. That's only

digital jargon for a multivibrator operating at about 250 kHz (in calculators). Multivibrators are old circuits, consisting of cross-coupled amplifiers with each output feeding the other input (see Figure 4). One transistor is saturated and the other cut off for lack of bias. Then the conditions reverse. Voltage at the collectors of Q1 and Q2 are either at supply voltage or nearly zero.

To prevent instability and shift of frequency because of varying load conditions, a buffer transistor (Q3) wired as a common emitter is used to supply the clock output.

Developing the minus supply

Two power supplies of opposite polarity are required. One, the positive supply, has the extra load of the display and must be able to furnish a comparatively-heavy current. This voltage comes from the internal batteries.

Because the minus supply is not so heavily loaded, it's economical and practical to develop it by rectification of the clock signal, rather than require the extra expense and room for another set of batteries.

One circuit used to produce -7 volts is shown in Figure 5. Pulses from point "B" of the multivibrator are amplified in two stages. The second of these stages is of the complementary-symmetry type. Rectification of these pulses is by a voltage-doubler circuit (shunt and series sections) often used in TV power supplies. Notice that the values are different because of the higher frequency, and that low-signal type diodes are used for rectification. Don't replace them

with standard power-supply type diodes.

Battery Indicator

Mistakes of calculation are not likely to happen because of low battery voltage. Brightness of the LED's gets dim before that point. However, it's helpful to know when the batteries need recharging. In a digital device, it's only natural for the designer to provide a digital readout of battery condition. Such a circuit is illustrated in Figure 6.

Zener diode D4 and R2 are connected in series between the pulses from D11 of IC1 and the negative supply voltage. When the minus voltage is normal, D2 conducts applying to the base of Q1 a voltage less positive than the emitter. Q1 is cut off. This opens the base circuit of Q2 which biases Q2 to cut off, also. Therefore, the segments of the display powered by Q2 are not lit.

If the minus supply voltage drops, zener D4 stops conducting and becomes an open circuit. Now, Q1 has forward bias through R2 from pulses whose amplitude exceeds the fixed voltage at the emitter. Q1 conducts, grounding the base resistor of Q2. This is forward bias for NPN Q2, and the resulting collector current flowing through the LED segments of the special left-most digit and the isolation diodes, D1, D2 and D3, causes the letter "L" to light up.

At this time, the operator of the calculator should stop using the machine and recharge the batteries, or plug in the charger to supplement the battery power.

Battery-Saver Circuits

Without the display illuminated, a typical calculator might draw a battery current of .05 amperes. However, with the display showing E88888888 (all LED's lit), the current can exceed .5 ampere, about ten times as much. It's plain why blanking of unused digits is desirable.

Most battery-saving circuits operate to extinguish all the digits if no entry is made or a command executed within a preset period of time (usually 10 or 20 seconds).

In Figure 7, positive voltages from IC1 (or the "digit" switch) forward bias Q1, and the low collector/emitter resistance grounds

C1, which charges up to the supply voltage. Also, the gate of Q2 is grounded through Q1, leaving the MOSFET without the positive gate voltage it needs for conduction. Without Q2 current, Q3 also is cut off; therefore, the display is illuminated.

If Q1 has no forward bias because no entries are made, its collector circuit will open. C1 and R1 are in parallel, and C1 is charged from the previous step. Therefore, the gate of Q2 is at zero volts. Then C1 begins to discharge through R1, gradually decreasing the voltage across C1 and making the gate of

Q2 become more positive. Q2 gradually draws more current until Q3 is forward biased into conduction, which causes the collector to ground a pin of the display-interface IC, stopping the current flow to the display digits.

Making another entry causes the display to light again. Or you can use the "D" (digits) button to make the LED's light for another time period. Length of the time period depends on the LR time constant of C1 and R1.

An alternate approach to display blanking is to use Q4 and Q5 of Figure 8 as series switches between the power supply and the display-

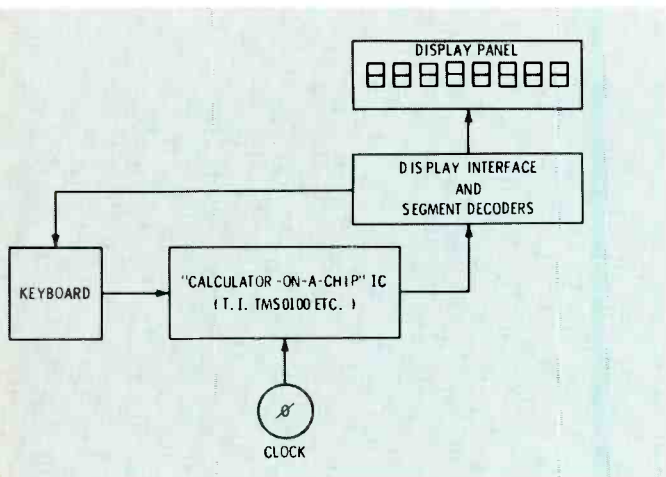

Fig. 1 Block diagram of a typical calculator.

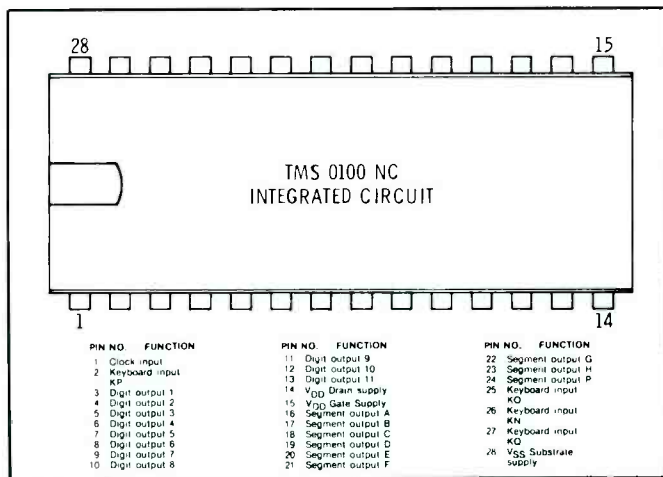

Fig. 2 Pin number and functions of a calculator IC.

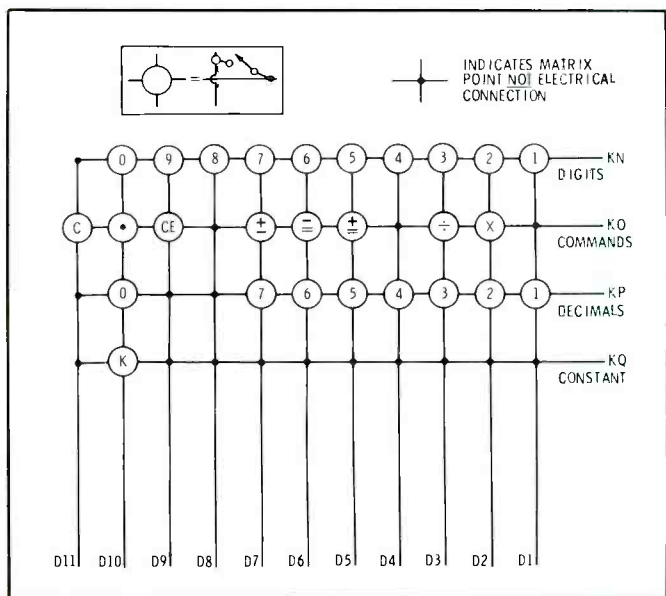

Fig. 3 A keyboard connects together one vertical and one horizontal bus when a button is pressed. For example, number 7 is entered by shorting together KP and D7.

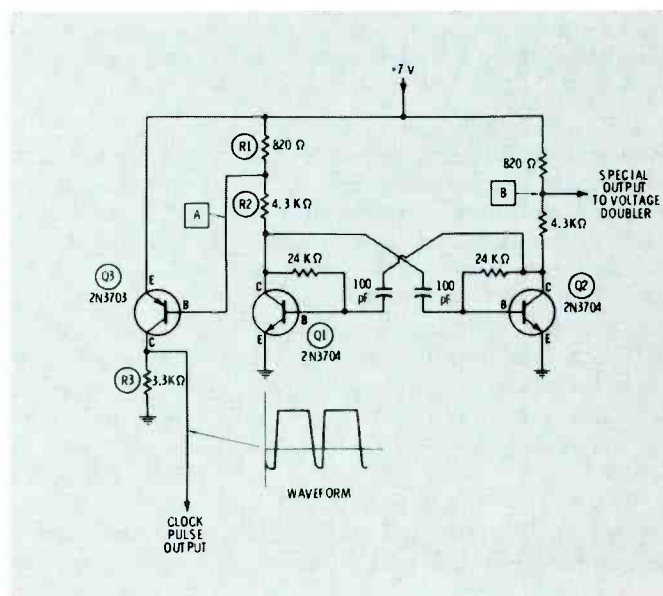

Fig. 4 A digital "clock" is merely a multivibrator, whose output waveform is nearly a square wave. A buffer stage provides isolation.

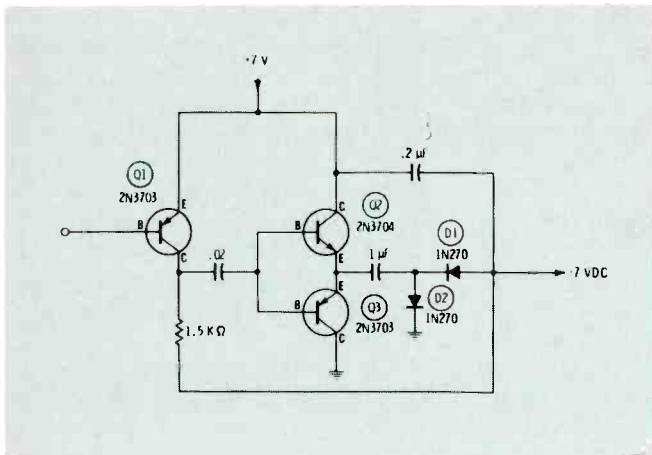

Fig. 5 Output signal from the clock is amplified by these two stages, then rectified by D1 and D2 in a voltage doubler circuit. Frequency is about 250 KHz.

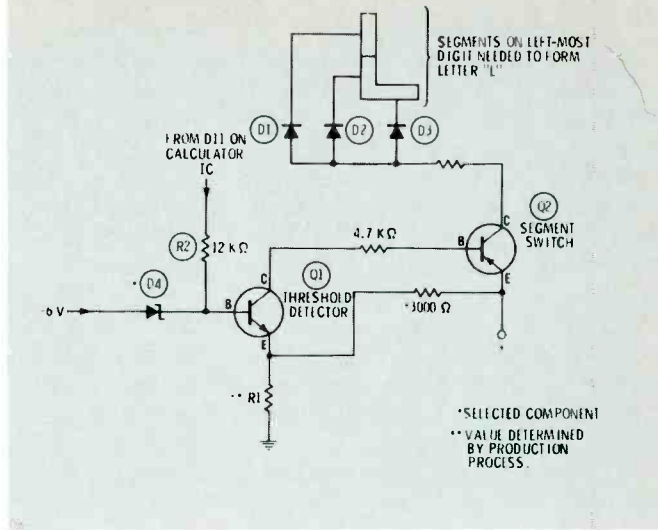

Fig. 6 Low battery voltage is indicated by this circuit which lights segments of the special-character digit to form an "L".

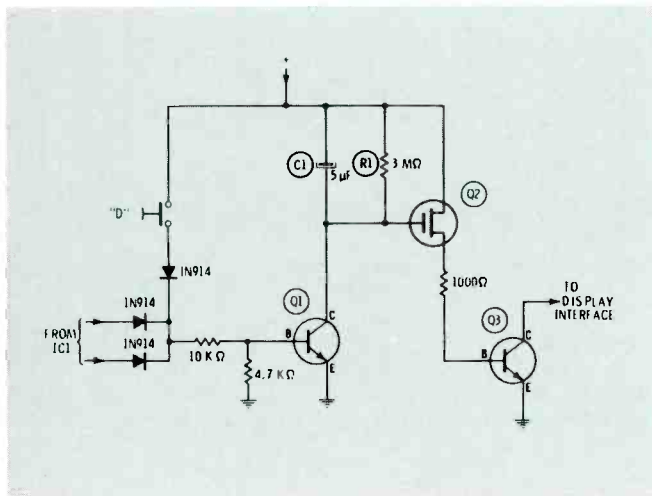

Fig. 7 After a time delay of 10 to 20 seconds, this circuit blacks out all display digits to reduce the current drain. Time of the delay is determined by the RC time constant of C1 and R1.

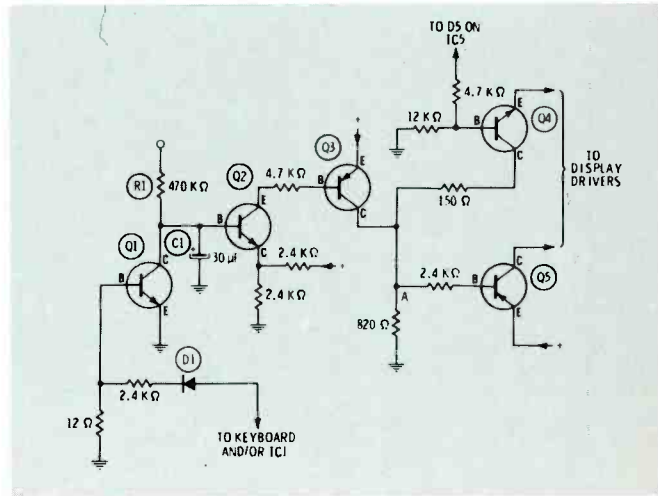

Fig. 8 Another circuit for blacking out the display if not used for several seconds. Time delay also is determined by the values of C1 and R1.

interface IC. Both must conduct for the display to remain lighted.

When an entry is made or the "D" key pressed, positive voltage travels through one of the isolation diodes (only D1 shown) to forward bias the base of Q1. The collector of Q1 draws current through R1 and also drains any voltage left in C1, giving a near-zero voltage at the collector of Q1 and the base of Q2.

Because of the fixed positive voltage at the emitter of Q2, this is reversed bias for Q2, and no collector current flows. Q3 is a PNP-polarity type, so the increase of positive voltage at the collector of Q2 and the base of Q3 is cut-off

bias for Q3. This reduces the positive voltages at the collector of Q3 and the base of Q5. Q5 also is a PNP and is forward biased by the reduction of base voltage. Therefore, the digits are illuminated.

If no digits are entered, Q1 is without forward bias, its collector doesn't short out C1, which now begins to charge to a positive voltage through R1. The speed of charge depends on the values of C1 and R1. When the voltage at C1 (and the base of Q2) increase to about .6 volt more than that at the emitter of Q2, Q2 is forward biased. This decreases the voltage at the base of Q3, increases it at the collector of Q3 and the base of

Q5. Now Q5 is biased to cut off and the display is blacked out. It remains out until another entry is made or the "D" button pressed.

Power Supplies

Most pocket-sized calculators use several nickel-cadmium (Ni-Cad) batteries in series to supply the positive voltage requirements. A "trickle" charger (Figure 9) recharges the Ni-Cad cells over a period of several hours.

Servicing Calculators

Before tackling a calculator with a trouble, we advise that you open up and examine a similar one that is not defective. Measure voltages

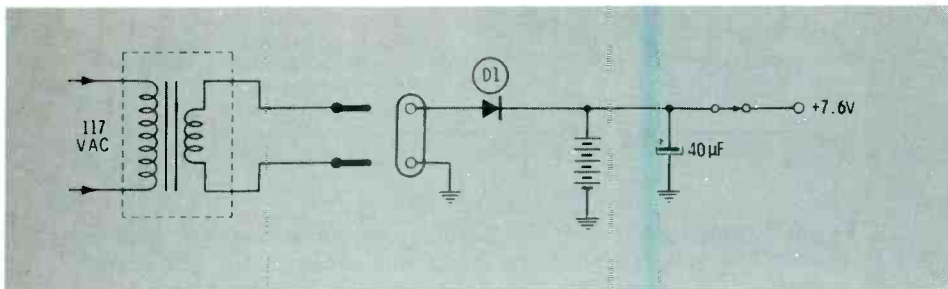

Fig. 9 An external power transformer and internal diode supply a trickle charge for the Ni-Cad batteries.

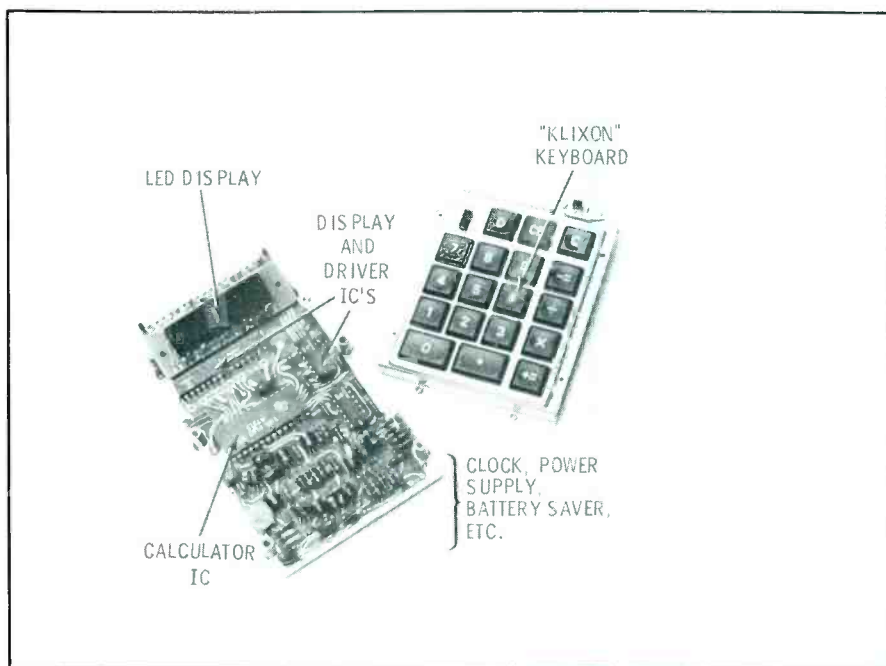

Fig. 10 Location of the major parts in a Heath IC-2009 calculator.

and waveforms. Locate the major components and connections to be used for test points. I built a Heath IC-2009, and recommend that you learn by building a kit of some brand.

Figure 10 shows the Heath chassis and keyboard separated as you would do during most repairs. When you remove the back cover, use care because it also functions as the battery retainer. If you're careless, the battery bank might fall and break the connections at the board or the power switch. Also, make sure the battery connections don't short against anything on the circuit board.

More screws hold the keyboard

and PC board to the front case. For most repairs, these two assemblies must be separated. The keyboard has a small PC board, and is connected to the main board by a series of connectors which serve both as electrical conductors and as mechanical fasteners.

The display panel with the LED's is mounted at one end of the circuit board. In some calculators, the panel is soldered into place. In others, it's fastened by connectors.

Damage versus defects

"Portable pocket-sized calculator" is a descriptive term which places many of the repairs in the same category as those necessary

for portable pocket-sized radios. That is, both products are very susceptible to damage if they are dropped.

Fairly easy to find are the damages by what I might call "macro-busts". These are things such as broken cases, switches or circuit boards.

Much more difficult to spot are the results of "microbusts". Hair-line intermittent cracks in the boards or around connecting pins often can be found by using a magnifying glass. Sometimes it helps to spray suspected areas with circuit coolant and look for the cracks.

Although the large calculator IC's have been fairly reliable, you might want to stock one each "just in case." Texas Instruments and MOSTEK are two major Original Equipment Manufacturers (OEM).

Test equipment

Nothing unusual in test equipment is needed for servicing calculators. A scope capable of showing good sharp 250-kHz square waves, and a VTVM or FET meter for voltage and resistance measurements are the only items needed.

Test methods

One of the first tests of an ailing calculator is to see if all the digits will light up with "eights". If they do, all the LED segments are okay. If some do not, try a different number which should use the segments that don't light. A defective LED is indicated, if it still doesn't light; or an open isolation diode, if it does.

Next, try some sample calculations to see which ones work correctly and which don't. One such calculation was given last month.

Replacement of the plug-in IC's is always a valid test.

Calculator troubles often run in cycles, the same as troubles do in TV sets. If you service only one or two brands, you'll soon learn the typical failures and thereby increase your speed.

No one but the calculator designers know exactly what goes on inside the calculator IC. Happily, it isn't necessary that we know. The main hint for successful repairing is just to take these articles and the factory schematic and troubleshoot a few units. You might be surprised to find it isn't too difficult. □

ARROW AUTOMATIC STAPLE GUNS

CUT WIRE & CABLE INSTALLATION COSTS

... without cutting into insulation!

SAFE! Grooved Guide positions wire for proper staple envelopment! Grooved Driving Blade stops staple at right depth of penetration to prevent cutting into wire or cable insulation!

No. T-18—Fits wires up to 3/16" in diameter.

BELL, TELEPHONE, THERMOSTAT, INTERCOM, BURGLAR ALARM and other low voltage wiring.

Uses T-18 staples with 3/16" round crown in 3/8" leg length only.

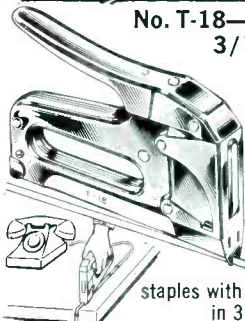

No. T-25—Fits wires up to 1/4" in diameter.

Same basic construction and fastens same wires as No. T-18.

Also used for RADIANT HEAT WIRE

Uses T-25 staples with 1/4" round crown in 9/32", 3/8", 7/16" and 9/16" leg lengths.

T-18 and T-25 staples also available in Monel and with beige, brown and ivory finish at extra cost.

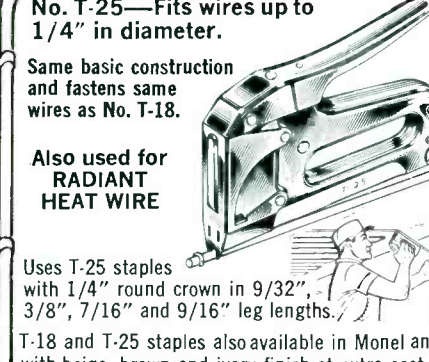

No. T-75—Fits wires and cables up to 1/2" in diameter.

RADIANT HEAT CABLE, UF CABLE, WIRE CONDUIT COPPER TUBING or any non-metallic sheathed cable.

Also used as **DRIVE RINGS** in stringing wires.

Uses T-75 staples with 1/2" flat crown in 9/16", 5/8" and 7/8" leg lengths.

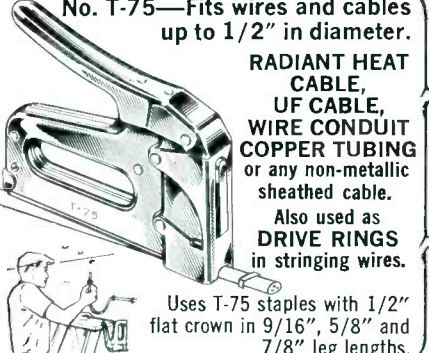

Arrow Automatic Staple Guns save 70% in time and effort on every type of wire or cable fastening job. Arrow staples are specially designed with divergent-pointed legs for easier driving and rosin-coated for greater holding power! All-steel construction and high-carbon hardened steel working parts are your assurance of maximum long-life service and trouble-free performance.

Ask your Electrical Supply Dealer or write for further details.

ARROW FASTENER COMPANY INC
Saddle Brook, New Jersey 07663
**"Pioneers and Pacesetters
For Almost A Half Century"**

42 For More Details Circle (12) on Reply Card

test equipment report

These features supplied by the manufacturers are listed at no-charge to them as a service to our readers. If you want factory bulletins, circle the corresponding number on the Reply Card and mail it to us.

Tuner Substitute

A fully-shielded compact tuner substitute is available from **Telematic**.



Model KT-730 Tuner-Mate portable Substi-Tuner operates on all VHF channels, with the capability of checking the output of the existing UHF tuner. It features variable RF gain to pinpoint trouble in the antenna, tuner or any stage of the IF. The Substi-Tuner is powered by two 9-volt batteries and is designed for bench or field use.

Model KT-730 sells for \$45.00.

For More Details Circle (33) on Reply Card

Digital Voltmeter

Model DVM 1600 digital voltmeter measures alternating and direct current in five ranges from .1 ma to 1 amp. AC and DC voltages are measured in four ranges from 1 volt to 1000 volts. Measurement of ohms is in six ranges from 100 ohms to 10 megohms.

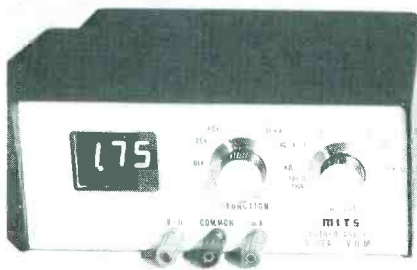

The resolution in low ranges is 10 mV for voltage, 10µA for current, and 1 ohm for resistance. DC voltage

accuracy is $\pm 5\%$; all other measurements are accurate to $\pm 1\%$. Input impedance is 10 megohms for DC voltage measurement and 1 megohm for AC voltage.

The DVM 1600 from **MITS, Inc.** features auto polarity which automatically displays polarity and magnitude without probe reversal, a regulated power supply, 2-1/2 digit Sperry tubes, and 100% overrange capability on all ranges. Power requirements are 115/230 VAC, 50/60 Hz, 20 watts.

Model DVM 1600 digital voltmeter sells for \$89.95 in kit form and \$129.95 assembled.

For More Details Circle (34) on Reply Card

Field-Strength Meter

The **Winegard Company** has introduced the FS-380 VHF-UHF field-strength meter.

The FS-380 measures absolute signal-voltage levels, is used for antenna surveys, identifies picture and



sound carriers, identifies interfering stations, measures daily signal fluctuations, and is helpful for setting up multiple-antenna installations.

It features a VHF range of 25 to 10,000 microvolts, dBmV scales from -20 to +40dBmV, separate VHF and UHF tuning sections, phone jack for identifying sound carriers (earphone provided), easy built-in calibration, long battery life (uses common 9-volt types), and standard "F" connectors. The FS-380 is portable and measures 82 TV channel picture and sound levels, as well as carriers between 88 and 174 MHz.

For More Details Circle (35) on Reply Card

AC Leakage Tester

An easy-to-use test instrument which is designed to check for potential shock hazards in electrically-operated home appliances, power tools, electrical fixtures, television sets, and industrial equipment is available from **RCA Electronic Components**.

Model WT-540A AC leakage tester has no switches, dials, or other controls and is used by connecting the black test lead to a suitable ground point and the red test probe to the metal parts of the product under test.

There is only one range and one meter scale, color coded red and green to indicate safe and unsafe leakage levels. Impedance at 0.5 mA is 1500 ohms (non-inductive) shunted by 0.15 μ F as required in the ANSI specifications. An internal fuse is provided to protect the tester from damage if the leads contact a device that is shorted or has extremely high voltage. As an added safety feature, excessive current that causes the fuse to blow will also cause the panel fuse indicator lamp on the front of the unit to glow.



Requiring no batteries, Model WT-540A is completely portable. It measures 2-7/8 X 4 X 2 inches and weighs 9 1/2 ounces. A special test clip is supplied to provide a simple check that the tester is operating and properly calibrated; the clip also provides a means of determining the ground and "hot" side of an AC outlet.

Model WT-540A sells for \$29.50.

For More Details Circle (36) on Reply Card

Portable Oscilloscope

Tektronix, Inc. announces the Telequipment D75, a dual-trace, 50 MHz, portable, delayed-sweep oscilloscope.

The D75 was designed with the electronic serviceman in mind. The tilt handle allows the D75 to be handcarried easily. The lightweight, portable scope measures 5.4 X 15 X 18.6 inches and weighs 25-1/2 pounds.

The D75 sells for \$1375.

For More Details Circle (38) on Reply Card

Transistorized Dip Meter

Leader Instruments Corp. has introduced a portable, battery-operated, transistorized dip meter, Model LDM-815.

The LDM-815 has a 310° calibrated dial, an indicating meter, 6 pre-adjusted plug-in coils, a 3-position function switch, sensitivity control, and an earphone for modulation monitoring. The unit uses a 9-volt battery, weighs 1.2 pounds, and measures 7 X 2-5/8 X 2 inches.

The LDM-815 dip meter sells for \$89.95.

For More Details Circle (39) on Reply Card

Solid-State Dual-Trace Scopes

Two 15-MHz oscilloscopes, Models 1220A (dual channel) and 1221A (single channel) are available from **Hewlett-Packard**.

Vertical gain ranges are from 2 mV/CM to 10 V/CM, so they are suitable not only for the general run of audio, video, logic, and control measurements, but also for such low-level uses as measuring the performance of IF strips.

The instruments are all solid-state, except for the CRT, and sixteen integrated circuits are used. Power dissipation is only 40 watts; therefore, heat is low. No fan is needed, so the cabinet is unvented and resistant to dust and moisture.

Features of the scopes include a large screen (8 X 10 CM), 3%-accurate vertical calibration, 4%-accurate time base, internal graticule for no-parrallax reading, DC coupling, automatic triggering, a ten-times expander, and a pushbutton beam finder. Front panel controls are grouped functionally for quick, easy operation.

Model 1221A single-channel oscilloscope sells for \$500; Model 1220A dual-channel for \$625. 10-to-1 divider probes, Model 10013A, with 10-megohm input shunted by 10 pf, are \$30 each.

For More Details Circle (37) on Reply Card

FREE HIGH VOLTAGE REPAIR KIT

with purchase of three CR-250 90° COLOR BRIGHTENERS

VP-180 SPECIAL!
\$18.00
\$23.00 VALUE

TeleMatic BRIGHTENERS WORK WHERE OTHERS FAIL

- HIGHEST boosting power
- COOLEST running
- PREFERRED by professionals

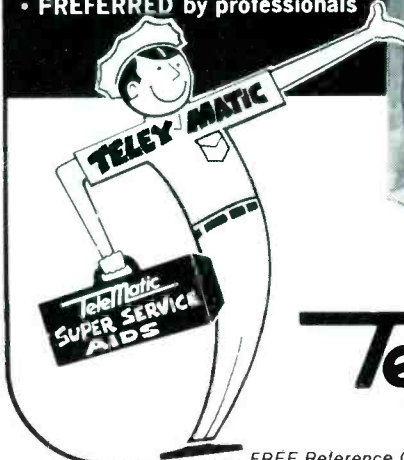

Made in U.S.A.

TeleMatic

Exclusively Thru Distributors

FREE Reference Charts. Telematic, Brooklyn, N.Y. 11207

For More Details Circle (13) on Reply Card

productreport

These features supplied by the manufacturers are listed at no-charge to them as a service to our readers. If you want factory bulletins, circle the corresponding number on the Reply Card and mail it to us.

Voltage Corrector

A line-voltage corrector designed for residential and commercial use is offered by **Essex/Stancor**. The unit electrically compensates for all but the most extreme brownout conditions.



The voltage corrector senses line voltage drops to 105 volts or lower and switches in an automatic transformer winding that boosts the voltage by 12% above the input voltage.

Operation is entirely automatic, requiring no adjustments, and colored lights indicate its mode of operation. Simple to install, the unit plugs into any convenient wall outlet, and the appliances or devices to be protected are then plugged directly into two receptacles on the voltage corrector.

Specifications of the unit are 115 volts, 60 Hz, 15 amps; it measures 10 X 5-1/2 X 6 inches and weighs 16 pounds. The voltage corrector sells for \$89.95.

For More Details Circle (40) on Reply Card

Pen for Marking Metal

A pen for applying permanent writing to metals is available from **Brookstone Company**.

The pen looks and works like a regular ballpoint yet the markings on all metals are permanent for easy identification. It writes on steel, stainless steel, silver, aluminum, brass, copper, cadmium plate, zinc plate, and nickel plate. Also featured is a replaceable cartridge that holds special acid for etching metals. The pen point is part of the cartridge which measures 5-1/8 inches.

The pen with cartridge sells for \$8.10 postpaid.

For More Details Circle (41) on Reply Card

Soldering Iron Accessories

A complete line of accessories is offered with the **Wahl Iso-Tip** cordless soldering iron.

The accessories include a carrier/storage tube, an auto-charger plug assembly, and four types of replacement tips. The carrier/storage tube offers a handy way to carry the iron and protects against accidental depression of the power button. The auto-charger plug assembly fits into a 12-volt cigarette lighter and can be recharged on the way to a job. Available replacement tips include the fine tip, general-purpose tip, heavy-duty tip, and 4-3/8-inch tuner-extension tip.

For More Details Circle (42) on Reply Card

Tuner Pads

PTS Electronics, Inc. announces the availability of a new tuner product, **PTS Tuner Pads**.

These pre-lubricated pads feature press-on installation for all turret tuners. The pads keep contacts polished and lubricated with the same lubricant used by all major tuner manufacturers. The tuner pads are cello packed, 12 per card.

For More Details Circle (43) on Reply Card

Time Control

To help home owners conserve fuel and electricity, **AMF Paragon Electronic Company** offers a heavy-duty 24-hour Time Command time control.

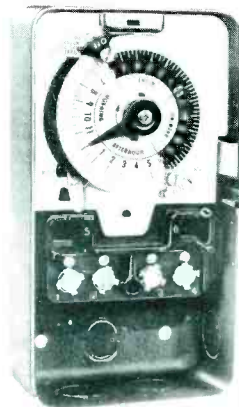

The unit can be wired into electrical circuits in the home to control outdoor and security lights, nighttime heating systems and fans, pumps, motors, water heaters, and sprinkler systems by turning them on and off according to schedule, up to seven times each day.

Time Command controls handle larger electrical loads than appliance-type time controls and become a permanent part of the electrical load circuit they control. A TC unit can be wired into a heating system thermostat circuit for periodic on-off cycling during the night, or it can be used to switch to a night thermostat. Fuel savings of 10 to 15 per cent are possible with a 10-degree Fahrenheit temperature setback at night.

For More Details Circle (44) on Reply Card

Alarm Installer's Tool Kit

A custom-designed, 60-piece tool kit for use by professional alarm installers has been announced by **Mountain West Alarm**. The MW-700 contains a set of tools selected for installation and repair of burglar and fire alarms, motion detectors, closed-circuit TV, and all other systems and devices currently in use in the alarm industry.

The tool complement consists of electronic alignment tools, burnishers, terminal crimping tools, feeler gauge, files, industrial magnet flashlight, magnifying glass, hammer and punch, icpick/scribe, dental mirror, electrician's knife, nutdriver set, five pairs of electronic pliers, rule, thirteen screwdrivers including a long screw-holding type, 21-piece socket set (3/8 and 1/4" drive), soldering iron, solder, soldering aids, scissors, spring tool, stapler, plastic stones for burnishing,



tape measure, continuity and voltage tester, tweezer, two adjustable wrenches, hex-key set, spline-key set, wire strippers, and a heavy-duty variable speed electric drill with large 3/8" chuck.

The new kit is priced at \$329.00 user net.

For More Details Circle (45) on Reply Card

antenna systems report

These features supplied by the manufacturers are listed at no-charge to them as a service to our readers. If you want factory bulletins, circle the corresponding number on the Reply Card and mail it to us

UHF Bandpass Filters

A new line of low-loss single-channel UHF bandpass filters have been introduced by **Jerrold Electronics**. The new units carry Model Nos. UBPF-14 through UBPF-70 (the numbers indicate the channel).

Encased in rugged die-cast aluminum housings, UBPFs are stable enough for use outdoors.

Each UBPF is designed to pass a specific 6 MHz band, with less than 2 dB insertion loss. Rejection is 20 to 25 dB six channels away and 10 to 15 dB three channels away. The units are flat within half a decibel through the passband.

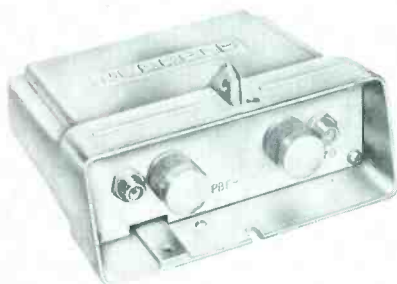

The UBPF is designed to eliminate the problem of overload of a UHF preamplifier. In an area with one or more strong UHF channels plus a weak UHF channel, a UBPF of the weak UHF channel can be used between the antenna and the preamplifier. The bandpass filter attenuates the strong channels preventing overload of the preamplifier.

UBPFs list for \$70.00.

For More Details Circle (46) on Reply Card

Variable Trap

A 75-ohm variable trap is available from **Blonder-Tongue Laboratories**.

Model MWT-4 is designed to attenuate undesired signals in the 108 to 174 MHz CATV midband. The trap is adjustable continuously over this range and its depth can be varied between 0.5 and 40 dB.

The trap has a single frequency attenuation of 60 dB plus and passes all other frequencies from 54 to 300 MHz with a maximum loss of 1 dB outside notch.

3 ways to deliver the clearest TV picture

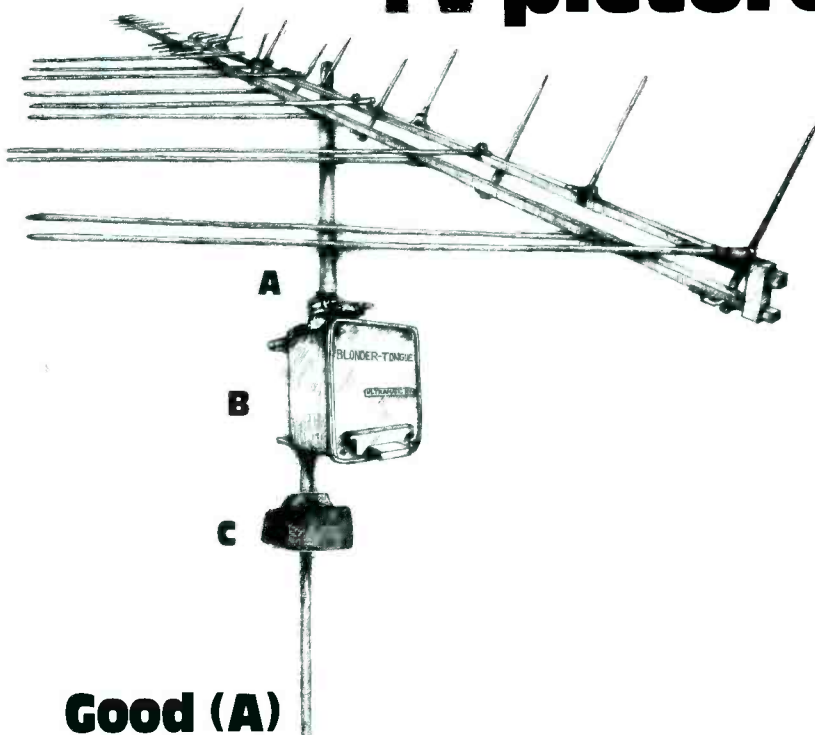

Good (A)

The all-channel Prisametric 0719 combines super-sharp VHF pick-up with high gain and flat response on all channels for top color performance. Uses 21 UHF reception elements for ghost-free and interference-free directivity. One of eleven Prisametric models, color certified for suburban and fringe areas.

Better (A+C)

Add the Horizon, ultra low-noise VHF two set amplifier to the Prisametric 0719. It's back-matched for clearer color pictures. Patented ICEF circuit delivers wide dynamic range so strong signals won't overload weak ones. Solid-state, trouble-free circuitry, four-way lightning and surge protection. Temperature compensation for all-weather reliability. Two individual amplifier circuits, one for channels 2 to 6, the other for 7 to 13.

Best (A+B+C)

A dynamic trio. The Prisametric 0719, the Horizon and Blonder-Tongue's new Ultramatic 1000 automatic rotator. Combines highest turning power of any unit on the market with ultra-precise positioning. Solid-state motor power switching eliminates moving contacts for greater reliability and repeatability. Motor uses filtered DC power supply for 1/3 higher starting and running torque. The differential amplifier in the servo loop insures accuracy within 2°.

These and other TV reception outdoor products are now a part of the Blonder-Tongue Product of the Month promotion at your dealer. Get details. Blonder-Tongue Laboratories, Inc., One Jake Brown Rd., Old Bridge, N.J. 08857.

BLONDER-TONGUE

For More Details Circle (14) on Reply Card

antenna systems report

(Continued from previous page)

Model MWT-4 suppresses interfering signals from VHF navigation aids, VHF communications and land radio communications. It also reduces aural carriers of CATV midband channels.

For More Details Circle (47) on Reply Card

Distribution Amplifier

Winegard Company introduces the DA-825B, an 82-channel distribution amplifier.

The DA-825B features an output level of 46 dBmV on each of 7 VHF channels and 45 dBmV on each of 5 UHF channels at 0.5% cross modulation.

A low noise figure of 3.6, dB on VHF and 6 dB on UHF helps to provide good color fidelity. It also passes mid-band and super-band, making the DA-825B compatible with any CATV system.

An FM trap is built-in to prevent overload from strong local FM stations, and it has a single input for UHF and VHF.

For More Details Circle (48) on Reply Card

Booster-Coupler Blister-Pak

JFD Electronics Corp. has announced a blister packed line of booster-couplers.



The full-color consumer-oriented package encloses the JFD product in a crystal-clear heavy-gauge poly blister form. On the front, the package describes the purpose and benefits of JFD booster-couplers. The back of the card provides complete, illustrated instructions written for quick comprehension by the do-it-yourselfer.

The new package, designed for

standard pegboard display, is used for the following JFD booster-couplers. For example, VHF/UHF/FM Model PC4382BP has one 300-ohm input and four 300-ohm outputs. It sells for \$48.15.

For More Details Circle (49) on Reply Card

Travel Antennas

Jerrold Electronics has developed two TV antenna kits (called Travelon) designed specifically for travel trailers, mobile homes, campers and boats. Because the antennas are spring loaded, they snap up easily.

Travelons have high gain on Channels 2 thru 83, plus FM. A periodic design provides the flat response needed for color reception. All elements are made of heavy-gauge aluminum with weather-resistant finish.

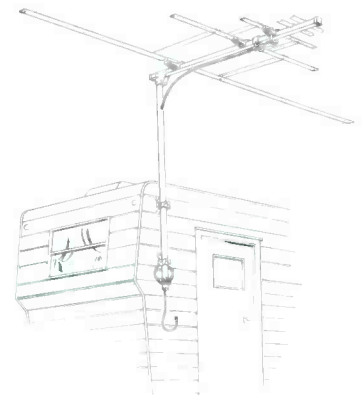

The Model TOTE-5K Travelon kit includes the antenna and a five-foot gold alodined mast, 15 feet of color-axial cable with factory-assembled connectors, an antenna matching transformer, a set-matching transformer U-V splitter, a neoprene grommet to take the lead-in through the skin of the vehicle, and all necessary mounting hardware. It sells for \$39.75.

For More Details Circle (50) on Reply Card

Matching Transformer

A 300-ohm to 75-ohm, all-channel, indoor-outdoor matching transformer has been introduced by Jerrold Electronics.

Model T-3789 is weather sealed for outdoor use and attaches easily to any 300-ohm output antenna, matching it to 75-ohm coaxial cable. It is also inexpensive and convenient enough to be used on the back of a TV set to match coaxial cable to the receiver input.

Model T-3789 sells for \$2.05 and is available bulk-packed and display-packed.

For More Details Circle (51) on Reply Card

We help him make it easier for you.

Your GE tube distributor is always there when you need him. With a complete line of GE entertainment receiving tubes, replacement semiconductors and ULTRACOLOR® or all-new Spectra-Brite® picture tubes.

Competitively priced. With fast delivery assured by his balanced inventory and the GE tube warehouse network. Along with all the technical information, business and technical aids you'll ever need. You can depend on him and GE tube products.

Tube Products Department,
General Electric Company,
Owensboro, Kentucky 42301

We're in this business together.

GENERAL  ELECTRIC

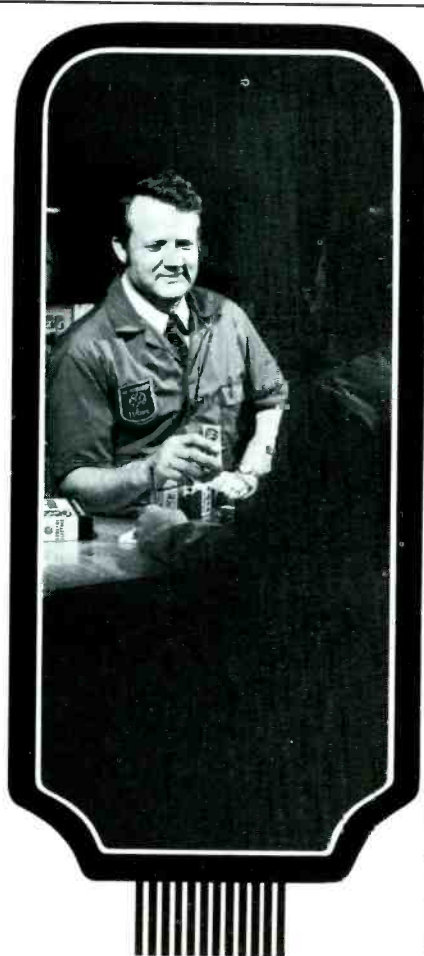

audio systems report

These features supplied by the manufacturers are listed at no-charge to them as a service to our readers. If you want factory bulletins, circle the corresponding number on the Reply Card and mail it to us.

Demagnetizing Kit



Valuable recorded tapes can be ruined when played on recorders not thoroughly and regularly demagnetized. That's because magnetism often builds up on recorder heads, tape guides and capstans, and from there is transferred to the tape. As a result, taped recordings lose highs and become progressively noisier each time they are played.

This common problem can now be solved by use of a new kit.

The Audiophile Han-D-Kit from **R. B. Annis Company** provides everything needed to measure and eliminate damaging magnetism. Included is a pocket magnetometer to measure residual magnetism, a clip-on extension probe to reach recessed components, dual-purpose Han-D-Mag demagnetizer, experimental test strips, and complete instructions. Han-D-Mag has a demagnetizing field strength of over 350 oersteds at 1/4-inch distance from the end of probe.

Two kits are offered by Annis. Economy kit 20/B5 at \$29.75 includes the standard magnetometer; deluxe kit 25/S5 at \$51.00 features a jewelled magnetometer with greater stability and accuracy.

For More Details Circle (52) on Reply Card

Wireless Microphone

Model WM-10 FM wireless electret microphone that transmits voice and music through any FM radio or tuner is available from the **EV-Game Inc.** Division of **Electro-Voice Inc.**

Created for home-broadcasting fun or commercial and live professional use, the WM-10 has a maximum microphone-to-radio transmitting distance of 100 feet. Carrier frequency range is 88 MHz to 108 MHz with drift-free stability. A tuning wand is provided to tune or change the microphone's transmitting frequency as desired. A standard 9-volt battery is required.

The WM-10 weighs only 2-1/2 ounces without the battery. It sells for \$29.95 retail.

For More Details Circle (53) on Reply Card

8-Track Cleaning Kit

An inspection and cleaning kit for 8-track cartridge recorders is available from **Nortronics Company**.

Model QM-7 inspection and cleaning kit for all 8-track cartridge machines contains QM-103 spray tape/head cleaner, QM-182 head/capstan cleaner, QM-504 maintenance brush and QM-509 inspection light.

Model QM-7 cleaning kit sells for \$9.90.

For More Details Circle (54) on Reply Card

Multi-Direction Speaker System



A new speaker system has been introduced by **Sansui Electronics Corporation**. The SP-1700 is a three-way, five-speaker system incorporating a mechanical high-cut-type 12-inch high-compliance woofer, a pair of 4-inch cone speakers with aluminum dome radiators for the mid-range, and a pair of 2-inch cone tweeters for the high-end. The SP-1700 can handle up to 70 watts of input.

Multi-Direction design of the SP-1700 involves the mounting of the two sets of mid-ranges and tweeters at interior angles to set up cross patterns of sound.

The SP-1700 reproduces frequencies from 30 to 20,000 Hz with cross-overs at 700 and 6500 Hz. It measures 25-1/4 X 16-3/4 X 10-1/8 inches. The price for the SP-1700 is \$189.95 retail.

For More Details Circle (55) on Reply Card

The right control for over 1,000 applications

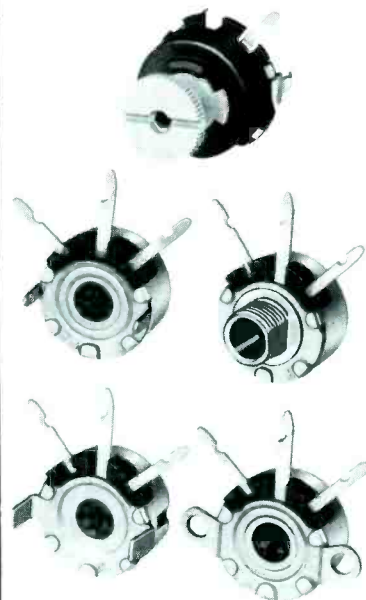

The right control for exact replacement is most often a Centralab miniature wirewound control. They're the time and temper savers for all your trouble shooting.

Centralab wirewounds are available in both 1 1/2 and 3 watt ratings in four mounting styles: flange, PC, tab and bushing mount. Resistance values range from 1.5 ohm to 15K ohms. And, for added convenience, nylon plug-in shafts and tandem twin couplers are available. Ask for Centralab wirewound controls from your Centralab stocking distributor.

DISTRIBUTOR PRODUCTS



CENTRALAB

Electronics Division
GLOBE-UNION INC.

5757 NORTH GREEN BAY AVENUE
MILWAUKEE, WISCONSIN 53201

For More Details Circle (15) on Reply Card

T & T VALUE SALE

NAME BRAND NEW JOBBER BOXED 77% Off List

- | | |
|--|--|
| <input type="checkbox"/> 1V2 5 for \$3.11 | <input type="checkbox"/> 6FQ7 5 for \$ 3.85 |
| <input type="checkbox"/> 2AV2 5 for \$4.08 | <input type="checkbox"/> 6GH8 5 for \$ 4.08 |
| <input type="checkbox"/> 3A3 5 for \$5.23 | <input type="checkbox"/> 6GJ7 5 for \$ 3.91 |
| <input type="checkbox"/> 3AT2 5 for \$5.06 | <input type="checkbox"/> 6HA5 5 for \$ 4.95 |
| <input type="checkbox"/> 3K5 5 for \$5.00 | <input type="checkbox"/> 6J6 5 for \$11.44 |
| <input type="checkbox"/> 3HA5 5 for \$4.95 | <input type="checkbox"/> 6J56 5 for \$ 9.54 |
| <input type="checkbox"/> 6BK4 5 for \$9.60 | <input type="checkbox"/> 8FQ7 5 for \$ 3.85 |
| <input type="checkbox"/> 6DW4 5 for \$4.83 | <input type="checkbox"/> 12GN7 5 for \$ 7.19 |

IEC NEW JOBBER BOXED 80% Off List

- | | |
|--|--|
| <input type="checkbox"/> 6GH8 5 for \$3.55 | <input type="checkbox"/> 6FQ7 5 for \$3.55 |
| <input type="checkbox"/> 6DW4 5 for \$4.20 | <input type="checkbox"/> 8FQ7 5 for \$3.55 |

RCA NEW JOBBER BOXED 75% Off List

- | | |
|---|--|
| <input type="checkbox"/> 3A3 5 for \$ 5.69 | <input type="checkbox"/> 6JC6 5 for \$ 6.31 |
| <input type="checkbox"/> 6BK4 5 for \$10.44 | <input type="checkbox"/> 6J6 5 for \$12.44 |
| <input type="checkbox"/> 6CW4 5 for \$ 7.94 | <input type="checkbox"/> 6JS6 5 for \$10.35 |
| <input type="checkbox"/> 6DW4 5 for \$ 5.25 | <input type="checkbox"/> 6KT8 5 for \$ 7.63 |
| <input type="checkbox"/> 6EA8 5 for \$ 5.50 | <input type="checkbox"/> 6K28 5 for \$ 5.75 |
| <input type="checkbox"/> 6FQ7 5 for \$ 4.19 | <input type="checkbox"/> 12AT7 5 for \$ 4.81 |
| <input type="checkbox"/> 6GH8 5 for \$ 4.37 | <input type="checkbox"/> 12HG7 5 for \$ 7.81 |
| <input type="checkbox"/> 6GN8 5 for \$ 7.94 | <input type="checkbox"/> 31LQ6 5 for \$11.31 |

TRANSISTORS XACT REPLACEMENT (BOXED) 80% Off List

- | | |
|--|--|
| <input type="checkbox"/> SK3006 5 for \$2.35 | <input type="checkbox"/> SK3039 5 for \$3.30 |
| <input type="checkbox"/> SK3009 5 for \$3.90 | <input type="checkbox"/> SK3040 5 for \$3.75 |
| <input type="checkbox"/> SK3018 5 for \$2.25 | <input type="checkbox"/> SK3041 5 for \$4.20 |
| <input type="checkbox"/> SK3020 5 for \$2.20 | <input type="checkbox"/> SK3042 5 for \$6.20 |
| <input type="checkbox"/> SK3024 5 for \$3.15 | <input type="checkbox"/> SK3052 5 for \$3.90 |
| <input type="checkbox"/> SK3025 5 for \$4.50 | <input type="checkbox"/> SK3054 5 for \$4.50 |
| <input type="checkbox"/> SK3026 5 for \$3.00 | <input type="checkbox"/> SK3114 5 for \$2.40 |
| <input type="checkbox"/> SK3035 5 for \$9.15 | <input type="checkbox"/> SK3122 5 for \$2.20 |

YOKES—TUNERS—FLYS

- | | |
|--|---|
| <input type="checkbox"/> Y130 Zen. 95-2874 ea. \$6.95—4 for \$25.00 | <input type="checkbox"/> Zen. B&W 95-2779 ea. \$6.95—4 for \$25.00 |
| <input type="checkbox"/> Y110 Mag. Color Yoke DY92 ea. \$ 5.95 | <input type="checkbox"/> Y107 21" Color 2 for \$11.00 |
| <input type="checkbox"/> Y104 DY68AT Fits Y105C without Plug ea. \$ 3.95 | <input type="checkbox"/> Silvertone Color Yoke Dy99AC 80-100-4C ea. \$ 4.95 |
| <input type="checkbox"/> Admiral Color Yoke w/o back cover & plug 94D379-6 \$ 4.95 | <input type="checkbox"/> Y109 DY95 Color Yoke w/o back cover 3 for \$10.00 |
| <input type="checkbox"/> UHF VHF Tuners Asst. Including tubes 3 for \$12.00 | <input type="checkbox"/> UHF Tuners Asst. 4 for \$ 5.00 |
| <input type="checkbox"/> Philco Color Flyback 32-10132-1 H0652C 4 for \$ 6.00 | <input type="checkbox"/> Sylvania B&W Tuners Inc. tubes 2 for \$ 9.95 |

GENERAL

- | | |
|--|--|
| <input type="checkbox"/> 3.58 Crystal Osc. 6 for \$ 3.00 | <input type="checkbox"/> 6500 PIV ITT Focus Rect. 10 for \$ 4.00 |
| <input type="checkbox"/> Zen. Voltage Tripler 212-136 ea. \$3.95—3 for \$10.00 | <input type="checkbox"/> 2.5 Amp 1000PIV IR170 20 for \$ 3.00 |
| <input type="checkbox"/> 24KV HV Rect. 2 for \$ 1.50 | <input type="checkbox"/> Color Burst Boost Rectifier 7 for \$ 2.00 |
| <input type="checkbox"/> 200-10.7 mc IF cans and others \$ 5.00 | <input type="checkbox"/> 66 meg resistors 10 for \$ 3.00 |
| <input type="checkbox"/> 53 meg resistors 10 for \$ 3.00 | <input type="checkbox"/> 19 & 25" Color Boosters 3 for \$11.00 |
| <input type="checkbox"/> 21" Color Boosters 3 for \$11.00 | <input type="checkbox"/> 19" Color CRT Sharp All New Repl. 19EX22-19GVP22 No Dud Req. \$39.95 |

ANTENNA SUPPLIES

- | | |
|--|--|
| <input type="checkbox"/> Finco MATV Mod. G922 300 ohm input 4-300 ohm output \$29.95 | <input type="checkbox"/> Finco #3020 2 Way Signal Splitter UHF VHF \$ 1.75 |
| <input type="checkbox"/> JFD Signal Splitter 82 channel SS21 ea. \$ 1.50 | <input type="checkbox"/> JFD BC2 Two Set Coupler ea. \$ 1.50 |
| <input type="checkbox"/> 72 ohm to 300 ohm matching transformer .. \$ 1.75 | <input type="checkbox"/> 2 set 72 ohm coupler \$ 2.95 |
| <input type="checkbox"/> 3 set 72 ohm coupler \$ 3.95 | <input type="checkbox"/> 5 set 72 ohm coupler \$ 4.95 |
| <input type="checkbox"/> 1000 ft. foam wire Columbia #22 \$19.95 | <input type="checkbox"/> 500 ft. Coax White 72 ohm \$14.95 |

AUDIO

- | | |
|---|--|
| <input type="checkbox"/> Ast Cartridge #148 5 for \$ 7.50 | <input type="checkbox"/> Ast Cartridge #142 5 for \$ 7.50 |
| <input type="checkbox"/> Varco TNO2 3 for \$ 4.50 | <input type="checkbox"/> Varco TN4B 5 for \$ 7.50 |
| <input type="checkbox"/> 60 min. Irish Cassette Tapes 6 for \$ 2.50 | <input type="checkbox"/> Electro Voice EV 5015 3 for \$ 6.00 |

Minimum Order \$35—F.O.B. Brooklyn
Catalogs \$1—Refundable upon your order

T & T SALES CO.

4802 AVENUE K
BROOKLYN, N. Y. 11234
Phone: (212) 241-5940

For More Details Circle (16) on Reply Card

(Continued from previous page)

Speaker System

Trusonic offers the JR-100M three-way tuned-port speaker system.

Both the 10-inch woofer and the 5-inch acoustically-isolated midrange driver feature viscous-damped fabric suspension which minimizes standing wave formation and subsequent harmonic distortion. The woofer incorporates a long-throw four-layer voice coil, a 4-pound ceramic-magnet drive assembly, and has a resonance of 22 Hz. Variable level control of the mid-range unit and the 1-inch horn-loaded dome tweeter permits shaping of the system's response to match the listening environment.

Rated frequency response is 30 Hz to 20,000 Hz; power capacity, 80 watts peak audio; and impedance, 8 ohms.

The JR-100M is priced at \$119.95.

For More Details Circle (56) on Reply Card

Phone Amplifier

James Electronics has introduced Phone-Ex, a "call camera" for extending the use of home and business telephones.

Utilizing a unique slip-on coil, Phone-Ex amplifies telephone calls to a room-filling level, so everyone present can hear both sides of the conversation. Messages can be taped on a cassette recorder, and the replay pushbutton will replay any recorded message back on the telephone line.

Phone-Ex is battery operated and requires no telephone wiring. It sells for \$39.95, complete with battery and step-by-step instructions.

For More Details Circle (57) on Reply Card

Audio Power Amplifier

A 100-watt RMS continuous-duty solid-state audio power amplifier is available from Pulse Dynamics Manufacturing Corp.

Model M-250 amplifier is designed for 4-8 ohm loading or 25-volt line application. Output characteristics include 1/4% typical harmonic distortion over 20-15,000 Hz frequency range. Circuit protection is by thermal circuit breakers on speaker and power lines.

Output transistors are protected from low-impedance loading by current-limiting circuits. The amplifier requires .8V across its 10,000 ohm input impedance to drive it to full output.

An interlocking feature provides for stacking of units, or ears are available for 19-inch relay rack mounting. Model M-250 amplifier sells for \$200.00.

For More Details Circle (58) on Reply Card

catalogs literature

Circle appropriate
number on Reader
Service Card.

100. Cornell Dubilier—has released an eight-page SCR-Capacitor brochure describing their paper, paper/film, and film dielectric capacitors. These units have been designed for applications such as SCR commutating, motor-speed controls, frequency changers, induction heating, electric vehicles, static power supplies, snubbers, resonant filters, choppers, and static switches.

101. General Electric—has announced availability of a 28-page catalog of service, advertising, and sales promotion materials for use by independent electronic technicians.

102. Heath/Schlumberger Instruments—has published a catalog which provides descriptions, photos, and specifications for instruments such as frequency recorders, oscilloscopes, power supplies, digital multimeters, recorder systems, an analog-digital teaching system, and the Heath/Malmstedt-Enke Lab Stations. Featured in the catalog is the new line of autoranging frequency counters and a low-cost strip-chart recorder.

103. H. K. Simon Co.—offers details of actual business increases gained by shop owners who applied the principles given in the business-promotion package which includes "How To Double Your Business" and "Television Sales and TV Service Promotion" supplement.

104. Jensen Tools and Alloys—offers a tool catalog describing 1900 items. "Tools for Electronic Assembly and Precision Mechanics" is a handbook of particular interest to electronic technicians. A feature of the catalog is the inclusion of technical data on tool selection. Known as "Jensen's Tool Tips", these four pages include sections on screw-driver selection, machine screw data, tool materials, plier facts,

metal conductivity, color coding, wire and insulation data, solderability of metals, temperature conversion, drill sizes, metal gauges, and safety.

105. Metropolitan Supply Co.—has a directory of electronic tubes which lists some 5000 industrial, entertainment and military tube types in alphanumeric order with quantity discount prices. Copies are available free when requested on company letterhead.

106. Mountain West Alarm Supply Co.—makes available three books, "Design For Security", "Silent Sentinels" and "Practical Ways To Prevent Burglary and Illegal Entry", which discuss security planning, management, locks, alarms, and electronics. A folder with detailed summaries of these books and how to buy them may be obtained by writing to Mountain West.

107. Nortronics Company—has introduced the fifth edition of their Recorder-Care Manual. The two-color, 32-page manual discusses magnetic heads, principles of magnetic recording, and recorder maintenance, and contains a catalog section which illustrates and describes recorder-care products by Nortronics.

108. PLC Electronics—announces the availability of a detailed 32-page catalog which lists 17 professional security systems designed for installation by electronic service technicians.

109. Rohde & Schwarz—has a new addition to the 1973 Rohde & Schwarz Instrument Catalog containing a selection of new test and measuring instruments. Those covered include mobile RF-meter and test set, RF-DC millivoltmeter, directional power meter, frequency counter, service test set, VHF-UHF monitoring system, radio-monitoring/recording system, TV-relay receiver, and TV-monitoring receiver.

110. Howard W. Sams & Co.—offers the new Audel Book Catalog, a colorful 48-page catalog describing 98 books which were written for the do-it-yourselfer, homeowner,

craftsman, or student. Some of the books included in the catalog are "Electrical Library", "Practical Electricity", "Radio and Television Library", and "New Electric Science Library".

111. Simpson Electric—has published a 40-page catalog which describes the complete line of Simpson test and measurement devices available from distributors. Catalog 4200 lists over 1500 types, styles, sizes and ranges of panel meters, more than 100 meter relays, and a variety of general and special purpose test equipment.

112. Stackpole Carbon Company—presents a comprehensive guide to performance characteristics and application criteria for fixed composition resistors. Bulletin No. 80-101 features selection and dimension data for 1/4, 1/2, 1, and 2 watt sizes, construction features, dimensions for various types of cut and formed leads, packaging options, and performance and testing curves.

113. Triplet Corp.—has released 59-T, a 16-page test-instrument catalog, featuring a tester-selection guide that allows direct comparison of performance characteristics of each model now available from Triplet. The 59-T lists VOM's and accessories, including general purpose, special feature, laboratory accuracy, digital, FET, portable, leakage adapters, cases, shunts, probes, and tester stands.

114. Tucker Electronics Co.—has announced the availability of a 160-page instrument catalog. Over 5000 test instruments are listed by nearly 600 manufacturer names. Many reconditioned, new and used sets are available, and a variety of rental and purchase finance plans are offered. The catalog features 18 sections divided by product category, and backed by an inventory of over 15,000 instruments. □

FREE CATALOG

HARD-TO-FIND PRECISION TOOLS

Lists more than 1700 items—pliers, tweezers, wire strippers, vacuum systems, relay tools, optical equipment, tool kits and cases. Also includes four pages of useful "Tool Tips" to aid in tool selection.

JENSEN TOOLS
4117 N. 44th Street, Phoenix, Ariz. 85018



A LITTLE SQUIRT stops all the noise.

A squirt of Quietrole from the handy Spray Pack silences any moving T.V. part. Cleans as it lubricates, too. Guarantees quiet, trouble-free operation. Absolutely safe for any black and white or color set. Try it and see why it's preferred by top servicemen everywhere.

Also available in bottles, and the new silicone—"Silitron."



Product of
QUIETROLE
COMPANY
Spartanburg, South Carolina

For More Details Circle (17) on Reply Card

need belts?



We've thousands in stock

Ready for immediate shipment! Belts for over 1800 makes and models of tape recorders, projectors, dictating machines, video recorders . . . and our simplified cross reference system makes it easy for you to order. Drive tires, wheels, phono idlers also listed. On most items we can ship the same day. Call or write today for your free catalog/cross reference chart.

PROJECTOR-RECORDER BELT CORP.
308 Whitewater St., Whitewater,
Wisconsin 53190 414/473-2151

BRADFORD 1104B44 (WTG-79343), 1104C44 (WTG-79350)	1385-1	GENERAL ELECTRIC Chassis CD	1382-2
BRADFORD 1105D34/E34/F34/G34, 1205A44 (WTG-80333A/41A/58A/66A/74A)	1388-1	GENERAL ELECTRIC Chassis 10HE	1384-1
CORONADO TV22-1012A	1386-1	GENERAL ELECTRIC Chassis 190A	1388-3
CORONADO TV22-1622A	1382-1	MGA CS-131	1389-1
CORONADO TV24-1025A	1388-2	MIDLAND 15-012, 15-012B	1380-1
CORONADO TV25-1632A/33A/43A (Ch. 9K18, 10K18)	1381-1	PANASONIC AN-809	1381-2
Remote Control Receiver 760A1462-1, Transmitter 750A1462-7	1381-1-A	PANASONIC CT-201	1387-1
DUMONT 19DP40W, 19DP70WR, (Ch. 35K18)	1390-1	PANASONIC TR-499	1382-3
Remote Control Receiver R200RE, Transmitter R200TE	1390-1-A	PANASONIC TR-542A/AC	1384-2
EMERSON Chassis 31K17, 34K18, 35K18, 36K18	1385-2	SONY Chassis SCC-17A-C, SCC-17B-C (Serial 300001 and later)	1389-3
Remote Control Receiver R200RE, Transmitter R203TE	1385-2-A		

the new automatics . . .

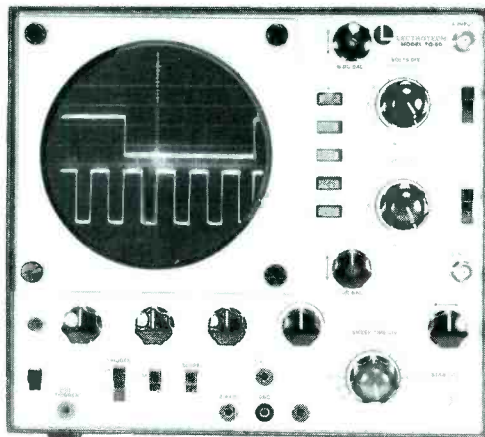

TO-60 dual-trace

TO-60 automatic dual-trace triggered sweep oscilloscope

Bandwidth: DC 15 MHz
10 mV sensitivity **\$459.50**

TO-55 automatic single-trace triggered sweep oscilloscope

Bandwidth: DC 10 MHz
10 mV sensitivity **\$349.50**

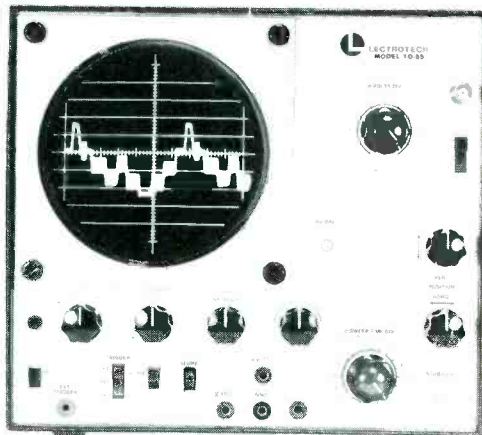

TO-55 single-trace

Made in U.S.A.

Two outstanding new five inch oscilloscopes with exceptional stability, featuring:

- Automatic Triggering • Automatic Astigmatism • Automatic Horizontal Sweep • Automatic TV Trigger Selection • All Switching 1-2-5 Sequence • Vertical Amplifier Sensitivity: .01 volts/div. • Horizontal Sweep Speed .2 Sec.-.5 μ Sec./div. • 5x Magnifier • All Solid State • TO-60 Dual Trace Capability: Channel "A", Channel "B", A-B Chopped, A-B Alternate, Sum of A & B.



See your distributor or write:

LECTROTECH, INC.
5810 N. Western Avenue, Chicago, Illinois 60659 (312) 769-6262



Available in Canada
from
Superior Electronics
Inc.

bookreview

TV & Radio Tech's Guide to Pricing, 2nd Edition

Author: John C. Sperry

Publisher: Sperry Tech Inc., P.O. Box 5234, Lincoln, Nebraska 68505.

Size: 7 X 9-1/2 inches, 87 pages

Price: \$18.00 looseleaf binder

This book describes a pricing system based on the amount of time required for typical repairs multiplied by the price per minute needed by your business for fair and profitable operation. Theory of the pricing system is explained in the introductory section, plus suggestions for solving pricing problems, estimating hourly rates, and repairing products that retail for less than \$50. The next section explains the 12 basic steps to understanding the pricing system, including invoicing, figuring estimates, minimum rates, call-backs and telephone inquiries. Twelve pricing examples are provided as a guide. The last three sections include two comprehensive listings of average times for both service calls and bench repairs of all categories of home-electronics products, and a pricing calculator for converting Tech's Guide minute figures into dollars based on your per-hour charge.

Pictorial Guide to Color TV Circuit Troubles (No. 644)

Author: Forest H. Belt

Publisher: Tab Books, Blue Ridge Summit, Pennsylvania 17214.

Size: 5-1/2 X 8-1/2 inches, 256 pages

Price: \$7.95 hardbound, \$4.95 softbound

Chroma circuit troubleshooting with a rainbow generator is made simple with this pictorial guide, containing over 200 waveform photos taken directly from operating and malfunctioning color TV sets. By comparing the waveforms in a troublesome circuit with those in this book, the reader can pinpoint the cause of trouble in burst amplifiers, color demodulators, color difference amplifiers, and color-video stages. The book is divided into nine sections. The first deals with the test signals used in color stages, and shows how to use a keyed-rainbow signal to track down color circuit troubles, and how to connect and operate a keyed-rainbow generator. The author then discusses various waveform types and the characteristics of each. A section on scope operation explains how to set up and adjust the scope so it gives the most useful and accurate information. The remaining sections deal with specific stages and the various signals appearing at the input and output.

The New Heathkit® Semiconductor Curve Tracer... \$89.95*

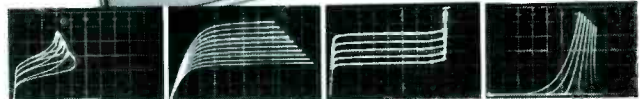
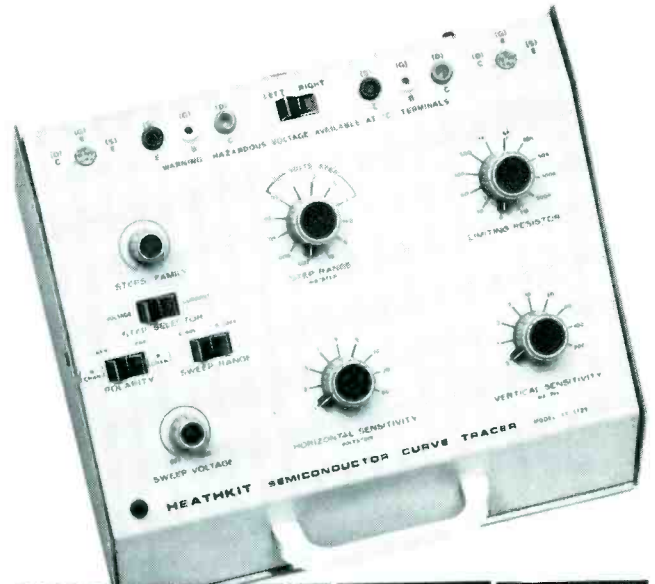

"Thermal Runaway"

Field Effect Transistor

Transistor Breakdown

Unijunction Transistor

This easy-to-build kit is an invaluable servicing tool. Hook up the Heathkit IT-1121 to an oscilloscope and you observe the fundamental operating parameters of virtually all types of semiconductors — bipolar transistors, diodes, SCRs, triacs, FETs, etc. The IT-1121 can be used to select devices for specific applications or for sorting, inspecting and testing. Extra leads are included for testing large devices or for in-circuit testing. The kit includes a comprehensive, fully illustrated manual showing how to interpret each display.

Any scope with horizontal sensitivity of 0.5 V/div. and vertical sensitivity of 1 V/div. can be used with the IT-1121. Connecting to the scope is easy with the cables supplied, and an external switch permits fast and accurate scope calibration. All major controls are stepped in a 1, 2, 5 sequence for maximum parameter resolution.

The Heathkit IT-1121 lets you take a good look at your solid-state servicing problem. Cuts trouble-shooting time and helps eliminate returns. And that can mean money in your pocket. Order an IT-1121 for your shop today.

Kit IT-1121, 11 lbs. \$89.95*

HEATH Schlumberger	
Heath Company Dept. 25-4 Benton Harbor, Michigan 49022	
<input type="checkbox"/> Please send latest Heath catalog.	
<input type="checkbox"/> Enclosed is \$ _____, plus shipping.	
Please send model(s) _____	
Name _____	
Title _____	
Company/Institution _____	
Address _____	
City _____ State _____ Zip _____	
*Mail order prices; F.O.B. factory.	
TE-303	

For More Details Circle (21) on Reply Card

SERVICE ASSOCIATIONS

NATESA News

Frank Moch, Executive Director of NATESA, urged in an open letter to William Simon, fuel coordinator for the federal government, that serious considerations be given to the gasoline requirements of technicians servicing home-entertainment products, in the event of rationing.

The one word best describing NATESA is **ombudsman**, an old word meaning someone who goes out of his way to help "little" fellows against powerful organizations that are not interested in fulfilling their obligations. To obtain help with legitimate business problems, NATESA members should write the condensed details to: NATESA, 5908 South Troy Street, Chicago, Illinois 60629, and enclose a self-addressed envelope for the reply.

NESDA News

Seven manufacturers conducted and 115 technicians attended the JESUP School last January in Arlington, Texas. In the overall evaluation, most attendees agreed it was an excellent school, which should be repeated each year. The next JESUP School is planned to be

held in Houston, Texas in July as part of the TEA annual convention.

TV-Electronic service dealers of eastern Illinois on January 16 organized under the name of Electronic Service Dealers Association of East Central Illinois (ESDA). Formation of the new organization was aided by NESDA officials Dick Glass (Executive Vice President) and Les Nesvik (Director of Education and Training), both of whom attended the meeting (see photo).

NESDA is located at 1715 Expo Lane, Indianapolis, Indiana 46224.



(Left to right) Dick Glass, NESDA Executive Vice-President, congratulates Jerry Martin, newly-elected President of ESDA. Looking on are: Norman Carlson, Director; Eddie Lane, Director; Dale Ronna, Director; Warner Bandy, Treasurer; and William Young, Secretary. All except Glass are officers of ESDA.

"The Country Boys" Have It!

Make Your Own DRIVE BELTS & "O" RINGS



PRODUCE
INSTANT
DRIVE BELTS &
"O" RINGS

Three Kits do it all! Your kits eliminate need for stocking large replacement inventory. This is all you need to make easy repairs on . . . 8 tracks, cassettes (both imports and domestic) whether drive belt is round, flat or square. Kits come complete with ample rubber stock, Instant-Weld Adhesive, jig for controlling cuts, razor blade and special cleaning compound.

- ORK-1 Round Rubber Drive Belt Kit
- ORK-2 Flat & Square Rubber Drive Belt Kit
- ORK-3 "O" Ring Kit

No "down time" . . . no specials . . .
no molds . . . no vulcanizing.



Write for our complete catalog and discount prices.
ONEIDA ELECTRONIC MFG. INC.
MEADVILLE, PA. 16335



George Dalton

ELECTRONIC
MFG. INC.
Oneida

NARDA News

Educate your technicians to collect cash for service. That's the good advice given by John Gooley, NARDA's manager of the service division, during many of the Service Symposiums he conducts around the country. First, inform the technicians about the legitimate expenses of the business, so they know the charges are fair. Then they should not be apologetic when asking for payment when the work is completed.

Theme of the National Appliance and Radio-TV Dealers Association (NARDA) convention in March was "Retailing Challenges of 1974". According to **Home Furnishings Daily**, one of the highlights was the review of one dealer's operation by a group of dealers in an effort to be critical constructively. □

**Give . . . so more will live
HEART FUND**

Tax Deduction

(Continued from page 24)

rooms used exclusively for an office:

Item	Annual expense
rent	\$ 2400
utilities	200
cleaning	520
insurance	300
<hr/>	
sub total	\$ 3420
home-office 1 room	
entire home 5 rooms	
<hr/>	
1/5 X \$3420 =	\$684
Plus depreciation of office furniture and equipment	\$112
<hr/>	
total allowable office rent	\$796

A home owner with a six-room house, using one room exclusively as an office might report these figures:

Item	Annual expense
real-estate taxes	\$ 1000
interest on mortgage	700
utilities	240
cleaning	580
insurance	520
depreciation on building	2000
heating	354
<hr/>	
sub total	\$ 5394
home-office 1 room	
entire home 6 rooms	
<hr/>	
1/6 X \$5394 =	\$899
Plus depreciation of office furniture and equipment	\$112
Repairs to office	\$50
<hr/>	
total	\$ 1051

Notes: The IRS won't allow deductions for landscaping and gardening. However, the unused portion of real-estate taxes and mortgage interest can be claimed if itemized on the long form.

How does the IRS look at it?

According to IRS rules, a room used both for a home-office and for other purposes can have a deduction limited to the number of hours used for business purposes compared to the total number of hours in a day. Thus, the IRS only wants to allow 3/24 to a taxpayer who uses his home-office for three hours each night, and the room is available during the day for family use.

This irrational method has been struck down by a Tax Court as being unreasonable. By the Tax Court figuring, the ratio is between the number of hours used for business versus the number of hours used for family living (not the hours available).

An important factor in substantiating any deduction for a home-office is to be able to prove the expenses involved, and that the room actually was used as an office. A diary or other substantiating evidence usually is required. A picture of the room in actual use might be a very effective piece of evidence.

In case of an audit

Suppose the IRS during an audit questions your right to a deduction for a home-office. Because many past court decisions have favored the taxpayers, you should refuse to

sign Agreement Form 870. Instead, take the matter to District Conference or to an Appellate Conference, threatening all along to go to the Tax Court. If the case gets to court, undoubtedly the court will affirm previous decisions protecting past deductions, and setting precedent for your future deductions.

Be sure your deductions are legal and without mistakes of arithmetic, then proceed with confidence.

endeco Soldering and Desoldering KITS



Model 500K
12-piece
desoldering kit
\$21.55 NET

- Soldering kits • Desoldering kits
- Soldering-Desoldering kits

Everything needed to solder or desolder, or both. Featuring new Endeco soldering and desoldering irons with safety light... the irons professionals really appreciate. Tips, stand, desoldering head and cleaning tool included, as required, all in a metal box with hasp. \$21.55 to \$39.65.

To locate your nearest distributor
call toll-free 800-645-9200



5127 EAST 65TH ST.
INDIANAPOLIS,
INDIANA 46220
PHONE 317/251-1231

enterprise
development
corporation

For More Details Circle (23) on Reply Card

OWN YOUR OWN PICTURE TUBE REBUILDING BUSINESS

With Lakeside Industries rebuilding equipment you can rebuild any picture tube!

For complete details send name, address, zip code to

LAKESIDE INDUSTRIES
3520 W Fullerton Ave.
Chicago, Ill. 60647
Phone: 312-342-3399



For More Details Circle (24) on Reply Card

FREE ALARM CATALOG

Full line of professional burglar and fire alarm systems and supplies. 80 pages, 400 items. Off-the shelf delivery, quantity prices.

 **mountain west alarm**
4215 n. 16th st., phoenix, az. 85016



For More Details Circle (25) on Reply Card



Time
for caring
birth defects
are forever
unless you
help

give
to the
March
of
Dimes

THIS SPACE CONTRIBUTED BY THE PUBLISHER

The MARKETPLACE

This classified section is available to electronic technicians and owners or managers of service shops who have for sale surplus supplies and equipment or who are seeking employment or recruiting employees.

Advertising Rates

in the Classified

Section are:

- 25 cents per word (minimum \$3.00)
- "Blind" ads \$2.00 additional
- All letters capitalized 35 cents per word

Each ad insertion must be accompanied by a check for the full cost of the ad.

Deadline for acceptance is 30 days prior to the date of the issue in which the ad is to be published.

This classified section is not open to the regular paid product advertising of manufacturers.

FOR SALE

COMPLETE SET SAMS PHOTOFAC #1 to #1367 with file cabinets. Will take best offer. Snow's, 150 Center St., Auburn, Maine. Phone AC 207 783-2251. Ask for Russell Snow. 4-74-1t

TEST/REJUVENATE color CRT's with b/w CRT tester/rejuvenator. Simple instructions \$1. TIPS, Box 188, Bruce, Miss. 38915. 4-74-2t

TV & RADIO TUBES 36c EA!! Free color catalog. Cornell, 4221 University, San Diego, California 92105. 2-74-6t

USE YOUR SCOPE (ANY MODEL. NO REWIRING) TO TEST TRANSISTOR IN/OUT CIRCUIT. SIMPLE ISTRUCTIONS \$1.00. SCHEK TECHNICAL SERVICES, 8101 SCHRIDER ST., SILVER SPRING, MARYLAND 20910. 10-73-12

UNUSUAL SURPLUS AND PARTS Catalog. \$1. ETCO Electronics Dept. E.S., Box 741, Montreal "A" H3C 2V2 12-73-12t

TV REPAIR BUSINESS in Bridgeport, Nebr., for someone who wants plenty of work. Equipment & stock list \$5000. All SAM's too. Asking \$3000. Great hunting & fishing country. Write Box 670, Bridgeport, Nebraska 69336. 3-74-2t

SURPLUS!! Tubes 19c, resistors 2c, other parts. Free catalog! TIPS, Box 188, Bruce, Miss. 38915. 4-74-2t

REPLACEMENT TRANSISTORS: Up to 60% below dealer net! Send for details. Kenneth E. Hull C.E.T., 835 Halesworth Dr., Cincinnati, Ohio 45240. 4-74-3t

FREE TUBE AND SEMICONDUCTOR CATALOG: Crown Electronics, 501 Baldwin Ave., Lodi, N.J. 07644. 4-74-1t

FOR SALE (CONT.)

LEADER LBO-501 TRIGGERED SWEEP SCOPE and B-K 1076 T.V. Analyst. A-1 condition. Both with probes, instructions, etc. Lot price \$625.00. Write Jay's T.V.-Radio Clinic, 945 Clay Ave., Stroudsburg, Pa. 18360. 4-74-1t

FOR SALE: Mc Murdo Silver Masterpiece V1 all band A.M. radio with solid mahogany cabinet. Electronics in perfect condition. Cabinet has a few slight scratches. Submit bids to, Larry Betts, Larry's Radio & T.V., 1200 Mackenzie Drive, Cranbrook - B.C. Canada. 4-74-1t

WANTED

WANT TO PURCHASE: One complete set of files of Sams Photofact folders, preferably from folder #300 to present, with or without metal filing cabinets. Robert Skrdlant, 802 Stella, Harrisonville, Mo. 64701. 4-74-1t

WANTED: TV tuner repair course. Earl Tichenor, 915 East 76 St., Chicago, Illinois 60619. 4-74-1t

advertisers' index

Arrow Fastener Co., Inc.	42
B & K Div., Dynascan Corp.	7
Blonder Tongue Laboratories, Inc. ...	45
Bussmann Mfg. Div., McGraw-Edison	25
Castle TV Tuner Service	Cover 3
Centralab Globe-Union, Inc.	47
Enterprise Development Corp.	53
GC Electronics	27
General Electric Company	46
Heath/Schlumberger Instruments. ...	51
Jensen Tools and Alloys	49
Jerrold Electronics Corp.	13
Lakeside Industries	53
Lectrotech, Inc.	50
Littelfuse, Inc.	Cover 4
Mallory Distributor Products	3
Mountain West Alarm Supply Co. ...	53
Oneida Electronic Mfg., Inc.	52
Panasonic Parts Division	1
Precision Tuner Service.	Cover 2
Projector-Recorder Belt Co.	49
Quietrole Company	49
Howard W. Sams & Co., Inc.	15
Sperry Tech, Inc.	23
Sprague Products Company	9
GTE Sylvania- Consumer Renewal	17-18-19-20
T & T Sales Company	48
Telematic	43
Tuner Service Corp.	5
Winegard Company	11

Work for free. The pay is great.

No matter what you do full-time, there's something you can do part-time. Helping people help themselves.

The pay is nothing but the rewards are fantastic.

Right in your own home town, there's a desperate need for your skills.

Whether you're a doctor. A lawyer. A typist. Or a tutor.

If you can spare some of your spare time, even if it's only for a few hours a week, call your local Voluntary Action Center. Or write: "Volunteer,"

Washington, D.C. 20013.

We'll put you in touch with the people who need what money can't buy. They need you.

Volunteer.

NOTICE

A Reader Service Number was inadvertently omitted from the March issue of ELECTRONIC SERVICING which carried four pages of color advertising featuring the line of test equipment manufactured by Hickok Electrical Instrument Co., 10514 Dupont Ave., Cleveland, Ohio 44108. (Telephone 216/541-8060; TWX 810-421-8286). Readers interested in obtaining additional information on Hickok products should write or telephone direct to the manufacturer or circle #60 of the Reader Service Card of April issue.

A Giant ... Steps Forward!

..... a truly fantastic, **BRAND NEW,** TV Service
Instrument

More than two years in development.

Modular microcircuit construction.

Masterpiece of miniaturization.

MASTER SUBBER™ MARK V

The GIANT in a tiny package



Designed for servicing the ENTIRE signal circuit system of any Color or Black & White Television receiver . . . by signal substitution!

Substitutes the following signal stages:

- VHF Tuner.
- Each video i.f. stage.
- Video detector stage.
- Video amplifier stage.
(Positive and negative going signals available simultaneously)
- 4.5 MHz sound i.f. amplifier stage.
- Sound limiter stage.

- Sound detector stage.
- Audio amplifier stage.

Provides tests for:

- UHF tuner.
- Antenna system.
- AGC system.

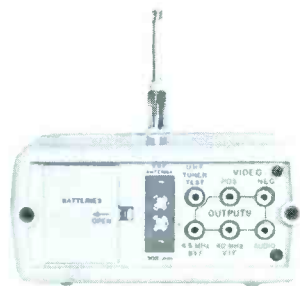

Use on the bench or in the home. Equipped with wall plug-in transformer for 120-vac line, instrument automatically changes over to internal battery power when transformer is disconnected.

Inbuilt monopole antenna allows use without connection of outside antenna in prime signal areas.

Inbuilt monitor loudspeaker with separate level control.

Video carrier level meter may be calibrated against Master Gain Control for the area in which the instrument is used, to afford true field strength measurements.

Lightweight . . . and measures a mere 6.5" x 6.5" x 3.25" exclusive of knobs, handle and antenna.

Complete with connecting cables and instructions.

You get all this for \$169.95 . . . at your stocking distributor.

. . . or write for more details and complete specifications.



CASTLE TV TUNER SERVICE, INC.

5701 N. Western Ave., Chicago, Illinois 60645 • Phone: (312) - 561-6354

In Canada: Len Finkler Ltd., Ontario

For More Details Circle (2) on Reply Card



24 hour watch



Everyday. All over the world. On millions of television sets, our sentry stands. The new Littelfuse Circuit Breaker. Meeting industry's new safety requirements of SE-O insulating materials, our breaker is demanded by virtually all set manufacturers. It's the perfect replacement part too!

Contact your nearest Littelfuse source. He'll show you the 19 available models with a variety of packaging choices.

24 hour watch. All over the world. It's a big assignment. But the Littelfuse Sentry is one of television's brightest stars.

LITTELFUSE

Littelfuse, Inc. Subsidiary of Tracor, Inc.
800 E. Northwest Highway, Des Plaines, Ill. 60016

For More Details Circle (3) on Reply Card